

# Visits to extraterrestrial civilizations

By: Ante Jonsson

Translated from the book of Ante (the contactee) and Sune Hjorth published by 'Zindermans Förlag', in 1989 - 149 pages.

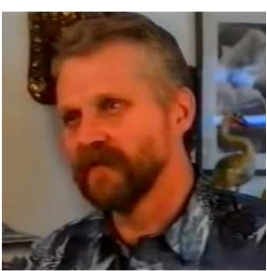

*Introduction. This story is about a Swedish man who in the 80s, was contacted by people from another planet, but the primary contact- a girl who appeared later - apologized for the strange way they initially tried to get his attention and initiate contact. Something he did not remember, as it was buried in his so-called subconscious mind. But despite the poor start, it became a fulfilling and very interesting contact.*

## Ante Jonsson writes about his first strange meeting.

On The night of Friday, February 3, 1984, I was on my way home by car from my friends in Ingelstad to my home in Tingsryd, about 20 km further south, in Småland southern Sweden. It was snowing heavily, the temperature was zero degrees and it was quite slippery. I probably kept to a speed of just over 70 km/h, but slowed down to 60 km/h near a path frequented by wildlife, where some accidents had occurred with crossing moose and deer. I was not far from Uråsa airfield. At the outskirts of a meadow on the left side of the road, I suddenly see a dark, rather small figure. My first thought is that there is someone on the way home to Uråsa or Väckelsång. In the middle of nowhere in the meadow I see such a large black object that seems to hang in the air about ten meters above the ground! I slow down some more and get the impression that the object is 70 - 80 meters long and between 5 and 10 meters high. The dark person I had just passed is nowhere to be seen. I lowered the car window to hear better, but not the slightest sound can be heard. A thought occurs to me: the camera! I step on the accelerator to hurry home and pick it up. Along the way, I think about what kind of object it might be. It could hardly have been a helicopter or an airplane - neither size nor appearance matched.

At home in Tingsryd, the house is dark, but my wife is awake and tells me to lock up the garage. I tell her I'm going to take my camera and go to Väckelsång to photograph a flying saucer or similar. While I drive towards Väckelsång at quite a high speed I think of the chance that I can maybe scoop the picture of a lifetime.

Arriving at the meadow, I find to my great disappointment, that the object has disappeared. But when I drive towards the exit road to Uråsa to turn around, I get to see something I never thought would be possible. I braked so hard that I spun around an entire revolution on the slippery road surface and came to rest with my headlights pointing straight towards the object, which stood still in the middle of the road with what I perceived as the nose facing me!

Since I could not get past, I tried to turn left to turn around. I got into another skid where I came close to colliding with the object. As it was, I clipped one a snow bank, continued across the Uråsa road and fetched up against another snow bank on its other side.

Unable to reverse, I opened the car door to get out and see how badly I was stuck.

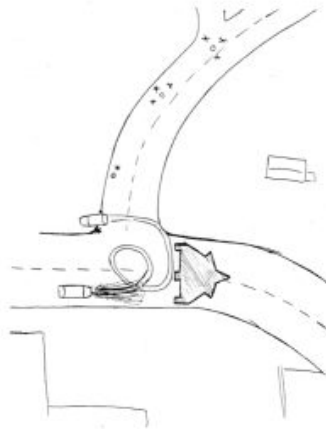

*(next - below - Ante tells how they tried to get him into their craft by force - but on a later contact, the spacegirl (Jenny, which was his primary contact) asked to be excused for using the wrong method - force - in this first attempt to get into direct physical contact with him - Rune comment).*



URÅSA - where the contact happened in south of Sweden

## FIRST MEETING

### **I was caught by a robot-like creature.**

I have never been timid or easily frightened, but what I saw when I opened the car door frightened me to such a degree, that it took a long time before I made a sound. But then I shouted as I think no human has screamed. I saw and felt a creature grabbing me and more or less lift me out of the car! I kicked and screamed all I could, and somehow I managed to get loose and started running towards a house off towards Uråsa-vägen. Then suddenly another creature stood before me, and the same thing happened again. It grabbed me, while the first one grabbed me from behind. I tried to get loose again, I lashed out wildly around me and struck one in what I assumed was the head. But they were the same pitch black as the craft, so I saw no face on any of them. Somehow, I tore myself loose again and ran towards the house. Then a third creature appeared before me, and the next moment I saw the craft again, hanging about ten meters up in the air! Now all three were on me and we rolled around on the road. As I understood it, they wanted me in the craft. Only now did I see that they did not have any legs/feet, they sort of hovered a short distance above the ground! I was so shocked I became like paralyzed and without any resistance on my part, we were on our way to the craft. I do not remember what happened next, maybe I had fainted. When they finally

released me, we first stood completely still and we looked at each other. Then I got to see the light from a truck that was heading in our direction. I started running towards the road, but my legs did not carry me but I crawled forward. As the truck drove by, I saw the creatures disappear obliquely backwards and upwards, retreating into the craft and I crawled to my own car.

I noticed that I was cold and wet on one foot and discovered that I had no shoes on me. Then I started shaking and getting some weird tingling in my hands and something uncomfortable in the throat. After that, I do not remember much, until there was someone outside the car. Later I learned that it was the police. I have a faint memory of them talking to me. Then comes a memory lapse that remained until I woke up at Sankt Sigfrid's hospital in Växjö. When I think about what happened afterwards, I regret a little that I did not voluntarily enter the craft (if I had not already been inside it), but I acted like anyone else would have done in my situation. And another thing I can't understand is why it was so quiet. The only thing that was heard was a barking dog.

I have read that these so-called UFOs emit both light and sound, but this was silent and not the slightest light was seen, not even a shade of grey on the black craft. Actually I would tell you a little about what happened at St. Sigfrid's Hospital while I was there. But the whole thing was so terribly ridiculous, that I hope no one will ever have to experience anything similar, it was so humiliating. I and the other patients were treated as if we was not more than 3-4 years old! There is obviously a lot that needs to be changed in the fine Swedish healthcare!

Discharged from the hospital, I am called to the criminal police in Växjö, where I am under some kind suspicion of being a spy and interrogated. In the end, not believed, I get placed at the "crime scene", that's all. Then I wondering why one does not do any survey of the places where everything took place, but the least strange explanation becomes the official story. I deny having been involved in photographing the airfield - as I have already told I was doing - but was there for completely different reasons!

What other matters do I find out from my wife? The police have been with her at our home announcing the stupid idea that I am a spy, hired by someone to go and take pictures of military airfields! They took my camera when they found it my car. They had interviewed my wife about what I was doing out in the middle of the night, and if she didn't think it was strange that I was not home at night? However, she did not think so, because I quite frequently photograph night scenes.

But the police stuck to their foolish idea that I am spying on military installations. But as I told them afterwards, if I wanted to spy on the military's military facilities, so I know well much better places than Uråsa airfield! I thought the police authority was there to help people in situations like this and not give feed other members of the family with a lot of incorrect and rude statements!

## **One month later (06-March-1984)**

The first time I came across these strange objects about a month ago, I was really scared and worried. But ever since this happened, I've had a weird feeling that I would meet them again. Several times when I went to bed it has been like as if someone called me, and it has happening on and off a couple of times a week. I have become worried and find it difficult to fall asleep again easily. I then get up and go into the kitchen and lit a cigarette to calm myself down. If it has been too difficult to unwind, I have gone out and taken a walk or drive.

In recent weeks, I have felt that someone wants something from me just before I go to bed. Then I tell my wife that I'll just walk around the block before I go to bed. I have not told her why I'm going out, because she would probably laugh at me. After the first meeting with those I now call **my friends from elsewhere** and what with what the police and doctors have told

my wife about my so-called ideas, she doesn't place much credence on what I say happened. I do not blame her for that either, because I hardly believe it myself - it's like a dream!

On the night of March 6, I woke up to someone grabbing me. I thought it was my wife, but she slept soundly, so I turned around to sleep on. But again, someone took hold of my left shoulder. I sat up in bed, and then I had the strange feeling that someone was calling me. I went out into the kitchen like so many times before, but the feeling that someone wanted something from me became even stronger. I got dressed and went out on the street. Under the street lamp nearby I had a smoke when I noticed someone on the street not too far away. He was bareheaded and wearing a long black jacket or coat. It was as if he was calling me, but not with any audible sounds or signs. I do not know why I went to him, but it felt like he wanted something from me. When I walk to where he was, he's gone. I think I have imagined everything and should return, when he reappears a little further away. I walk towards him, but at the same time he moves even further away, but always within sight. But, my God, he's not walking, he more or less floats forward, below the hem of his coat I see no feet!

When he is under a street lamp, I see that his face is almost chalk white and horribly narrow and long. I do not know why I follow him, but in the end he stops at a meadow located 600-700 meters from my home. He turns off into the meadow, and when I arrive to the meadow, I see for the second time in my life a big black vessel hanging there, and next to it stands another, rather short man!



I do not know why, but I suddenly feel completely calm. I stand for a moment and look out towards the object. Then I see the long craft again, just in front of the large craft. It looks the same as last time, though much smaller, maybe 10-15 meters long and 3-3.5 meters high. I can't see legs or wheels on it, just something resembling pontoons on a seaplane. I judge its height above the ground to be 2-3 meters. No movements are visible. It is dark and gloomy in colour, no lights or windows are visible. I hear a faint hissing sound, and then the man is gone, then it's just as quiet again. But the craft slowly lifts straight up, to then come towards me and stop 15-20 meters above me. Suddenly the craft lights up with a faint blue-green light, and in the middle it is completely white. Then the lights go out.

Now something happens that more or less makes me lose my breath: I am suddenly 25- 30 meters up in the air in a standing position, without being able to grab onto or touch anything! I see everything clearly. I do not hang on to any ropes or the like, and no one is holding me. It feels like I am standing on a solid surface, but there is nothing below me apart from the trees! How I got up I have no idea. A voice within me says I don't have to be scared, I try not to be, but when hanging in free space quite far up in the air without even a fellow human to call out to it is not easy! It probably did not take more than 10-15 seconds before I was suddenly lowered slowly and placed between a rock and a flowerbed in my own garden! Only now did I see the craft again, it hung just over a birch a short distance from my garden. At the same time, I saw four luminous dots the size of tennis balls approaching straight from the top down towards the craft, and then stop around it. Now they are significantly larger, perhaps closer to

a meter in circumference, with the craft in the middle, it looked like five on a dice. When the globe approached the craft they shone bright white, finally changing to a yellow-red colour, but still with white elements in the centre. The craft did not stop for long – seconds – but sets off down to the lake, which is 600-700 meters south. Oddly enough, the globe did not follow but slowly descended to the ground, where they appear to dissolve. I went into my home, into the bedroom and undressed and thought about what had happened, but I said nothing to my wife.

### **Journey to unknown planet (26-April 1984)**

Now it's happening again: I wake up at night with someone 'calling' me. I go out, discover the same figure I've seen before, follows him to the same place where I last saw the craft. I feel the familiar pleasant calm feeling, but when I discover the craft this time: I see a significant difference, There are now windows or the like visible. They are two meters long and 25-30 cm wide, and inside the craft it shines with a blue-green glow with some shifts in brown. But it is not a fixed light, it seems to move in waves. Suddenly I see a bright glow which sort of grabs me and pulls me into the craft!

What happens next is so wonderful and incredible that I hesitate to write it down. I find myself in a room very reminiscent of a large glass ball with one half opaque and one quarter of the second half with matt but transparent glass. After a while, I feel that someone else is in the room even though I do not see anyone. At the same time, I feel a vibration under my feet. When I look out the window, I see to my horror that we are no longer at the ground but a good kilometer up in the air!

I try to say something but can't. In some strange way, it feels like someone is asking me to be quiet and sit down. I look around for a chair or similar but find nothing other than a bench-like seat in front of that strange window, so I sit down there. But imagine my astonishment when as I settle into it, I'm enfolded in a soft yet firm grip.

Now the vibrations have become stronger and the window is no longer transparent, but there is still the same soft glow in the room. I estimate that it has been about two hours since I got into the craft. Suddenly someone is standing in front of me, the same short figure I have seen earlier. Now I see him clearly for the first time, including his face and features, the whole of him in fact. He is 150-160 cm tall, has a normal physique but longer arms than me. His hair is more or less uncoloured, it has grown around the periphery of his whole face, effectively hiding any ears. I see his two large eyes which are almost black, a flat nose without visible nostrils, a strong jaw and large mouth. No teeth are visible, the whole head is spherical in a somewhat comical way. He seems almost a little sad, but at the same time calm and gentle.

He extends an arm towards me, and in his hand he has something resembling a mug with some liquid in it. It looks like heavily diluted milk, a little greyish. His hand looks a like mine - the difference being that there are no fingers visible. He wants me to drink. I hesitate, but he insists, so I do as he requests. It was not very good, a bit bland taste, but still sweetish. I ask what it is, but get no answer.



Instead, he turns against a wall, and suddenly a luminous 'painting' becomes visible on the wall. Imagine my surprise when I can read completely ordinary words in Swedish: Also in some strange way, I also get information transferred to me by a Swedish male 'voice', it sounds as if I heard the voice from within rather than from outside myself. At the same time the luminous image shows a strange map with circular symbols of different sizes within green and blue fields, the voice says that there are other planets in our solar system where life exists similar to ours, but with higher intelligence and knowledge. Among other things, you have the ability to travel or move in space to distant places. I'm also informed that we could travel much faster if we used the "loops in space", whatever that might mean. We should also stop using nuclear weapons and the like, before a disaster strikes.

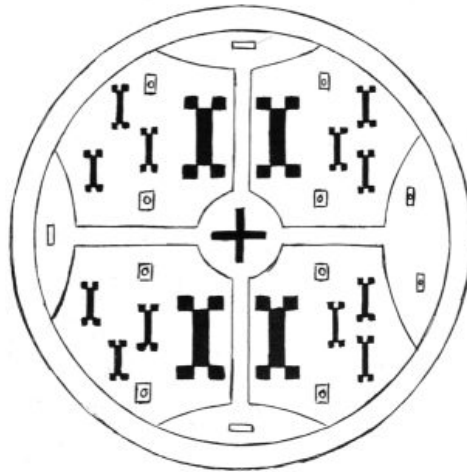

This was the last I 'heard', then the man was gone, the room got dark and I could look again. I thought I was down in the meadow again, but I was not. Admittedly, I saw a forest, some mountains and something resembling a city. Although it was not like our cities with their houses, streets and cars, it consisted of a lot of box-like buildings in different formats inside one circular high and wide wall. In the centre stood a kind of tower, shiny as chrome, and on an open one place on one side of the city stood two similar vessels to the one I was in.

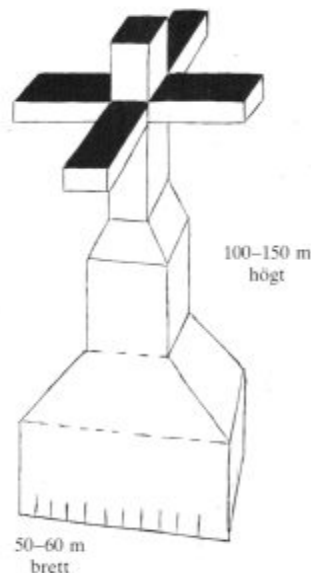

We moved slowly across the city and then across a kind of desert, towards a wooded area or mountain range. I only saw two kinds of trees in the forest, one reminiscent of larch trees and the other similar to palm trees with large brown clusters in the branches. When we had passed the forest and mountains, we came to a large body of water with land spits that went straight across from one side to the others, and on each peninsula stood a mass of towers with a box in the middle. That was the last I saw of all this, then we stepped straight up, and the window could not be seen through more. The vibrations were back and so was the man I met before. I had to sit down on that strange bench again. I probably had fallen asleep,

because I did not think so had been a long time before I stood in my garden again and saw how he set off down the lake.

But I got the feeling that we would meet again.

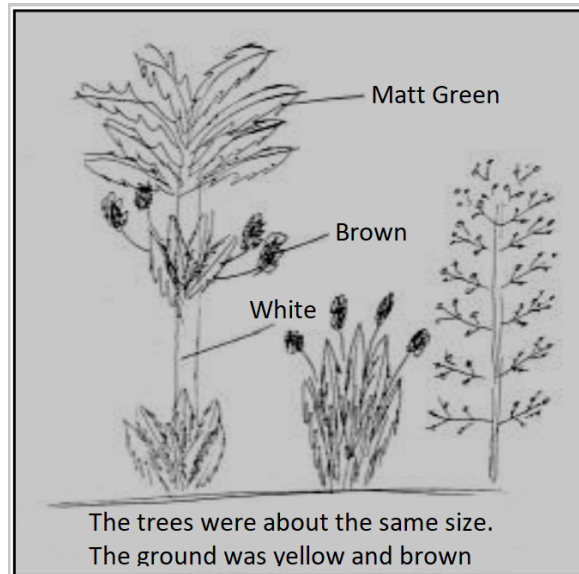

### **The second space journey (14-Aug-1984)**

It's been almost four months since I last met that man, so I thought it was over now. Maybe it was all just imagination? But now the same thing is happening again, the same inner voice as calls me. My youngest daughter and I have been asleep for a while, when I wake up because of his insistent call. He wants me to get up. I hesitate to leave my daughter alone, but the voice tells me she will sleep continuously. I do not want to leave her, but do it anyway. We go to the same road, same meadow.

This time I enter the craft myself, through a round opening, up a flight of stairs, into same sort of room as lasttime. But when I enter the room, there are four figures sitting there. Three of them are like the short man I met last time, and the fourth is probably the same person I saw once before on the street. He is taller than the others, has a white face which is reminiscent of ours though it is a bit narrower and longer with white hair. He asks me to sit down on one of those strange bench-seats that almost sucks me in place. When I sat down, a fifth figure came into the room and gave me a mug with the same drink I received before. I wonder what it is, but say nothing. I still get answers though from the pale man. He says I have to drink from this, because otherwise I can't make the trip through space. I ask where we are going and why. He explains that we will travel to the same the place like last time, but I'm back before morning. He wants to show me some things which we here on earth have completely misunderstood.

I ask why me and not others who might be more appropriate. He answers that there are also others who have been through the same things as I have and that there will be more. "You are one of the many who have a different belief/understanding than most in what you call Christianity and history. "I answer that there are thousands who do not believe in God. He says that deep down most of you probably do believe in God though you dare not reveal it. He wants to show me what the truth is behind our God and Jesus that we read and preach about. He also wants to show what will happen to us if we insist on manufacturing and using nuclear weapons. "What will happen?" I ask, at the same time I feel we have lifted off and are on our way up from the earth.

"You will see evidence of self-destruction. There were once people on an almost identical planet as you who began manufacturing nuclear weapons to fight among themselves. It started like on earth with a war between different groups of individuals and ended up wiping

out almost all life. All that's left today is only vegetation and some stations that we have erected to try to build up a new civilization. This is what we are going to show you so you can understand what it is you are maybe going to do to yourself and your planet. Others have already seen it, and now it's your turn. We have studied your society, for thousands of years, and the same pattern is forming on Earth as it did in the planet of the Delefs.

*(comment, have not heard that planet or civilization mentioned in other contact cases, but from the other information in this contact, it may be what the Semjase contacts mentioned as a group of 'the refugee planets' of the old Lyran- Pleiadian wars in this part of our galaxy, as also the both Earth and the Sirius -planets was a part of. Rune comment).*

"The one you call God (interpreted as physical 'God' or leader,) was a Delef who put his son on the Earth to tell you that you are on the wrong path. But Jesus was not the only one of the Delefs placed on earth. They were in many other places but did not get as much attention as Jesus because he performed some forbidden things like curing the sick. This was not so strange, because his father was a doctor on his own home planet. When this happened, that planet was already far ahead of you in all areas.

The ancestor of the Inca people was a delef, in India and in southern Europe there were also several delef. You were taught not only about justice/ righteousness but also in a building technique that you have forgotten completely today.

He asks me if we could cut and shape stone in the same way as is was done in the Inca Empire and Egypt in ancient times? If we could construct rock chambers that are as smooth as glass? "You have not learned to cut stone into slices, but should you find what you call Atlantis, then all of your civilization will changes in a few years! I will reveal to you that both the Inca and other ancient cultures used machines for most of their work. They got their machines from the Delefs. You have not found any remains of them, but such are found in Atlantis and also at inca sites and in some other places."

I ask him if there is any evidence around the world of their and the Delefs' existence. "Yes, but you just have not learned to interpret and recognise all the signs and things that the Delefs have left behind." I also ask about Atlantis, what it was and where it is now, but get one strange answer: "Start looking in your history, but interpret it correctly this time, and you will find it! Look not only on land but also outside Faros, so you get a starting point! "

I feel that the craft has stopped vibrating, and it has become bright at the window on the wall. I'm back again at the place from last time and wondering what will happen now. He says we should change vessel, for this to be reloaded/recharged. I'm wondering if I can go out, but apparently it's not no problem. Once outside, it feels like summer at home, just warm enough but drier air. We go through a tunnel and end up on a street with these strange houses on both sides. I can't help but to reach out and touch a wall, because they are so strangely smooth. He says it's stone and metal. "We have the same metals and stones that you use for your buildings, but we use a different alloy in our metal."

We arrive at another craft and enter. "Now I'll show you a destroyed planet, something which can also be your destiny!" This time I can't sit down but lie down on a similar bench like I sat on before. I think I slept for a while, because I did not remember anything from the moment we left until I was asked to sit up and look out. What I now get to see is something terrible, not least considering that we can do the same for ourselves on the earth. Cities almost buried in stone and sand, buildings and forests drenched in water, burnt and molten metal! The nasty thing about all this is that what is reasonably clear is that it is all so similar as to what is on our own planet. He says: "It is not so strange that it resembles earthly things, for it is the delefers who has taught you to build what you have and which has given you technology and science. The only thing they did not bring with them are the animals.

At one point I see that they are building some stone houses that they cut out of a mountain to then put on a metal framework. A large boulder is taken from the rock to the construction site with something resembling a barge. But it floats in the air and is then lifted as if by an invisible hand down to a platform where the boulder is placed between two large machines



that are similar tanks. It flashes from both sides, and then the block has been divided into several flat pieces. These then lowered one by one into a pool of water, and it steams when they are in the pool.

I find out they are keen: "We are going to build a new city here," he says. I ask when will be ready, because with your speed, a big city would be ready in a week. "About one month ", he replies. We continue to the other side of the mountain, where he shows me the place where this whole Holocaust started, now just a big hole of sand and gravel. Here had been a facility as large as Skåne (<http://en.wikipedia.org/wiki/Scania> with 10,939 km<sup>2</sup> or 4,224 sq mi)

producing the energy supply to half the planet. "But surely you can understand what would happen and who would believe me if I talk about this?" I ask him "What I can do about it?" There are so many on earth against the experiments with nuclear weapons and the like, You can succeed in getting your leaders to listen and understand that they are planning for their own downfall. We can do nothing to help you, because if we were to show ourselves - which we have done several times - we would have to defend ourselves. Your leaders take us for an enemy, but officially we do not exist for them! On several occasions we have been hunted down and shot at, but we would rather flee than fight. If we wanted to fight with you, we could do it, but it would be pointless, because there would not be anything left of you. I'll show you what I mean."

We continue a little further on, and he shows me an almost destroyed building. Then he asks me to look at the screen on the wall. We fly until we can no longer see anything of the place we were just, except on the screen. He says the distance is almost a hundred miles away from the building now. "He says: Watch now!" One flash and one clouds of dust, then it's over. We go back to the place, only to find that the building is just a smouldering pile of gravel. After this demonstration, we look around further on this huge rubbish heap of a remnant of a civilization that long ago ceased to exist.

### **We are on our way back to the previous planet.**

While we are on the road, we discuss and reason about the Delefs, how they got to Earth and how long they stayed. "They went to earth with their own vessels several hundreds of years before Jesus' birth. This Jesus whom you call the Savior was a Delef, and he was not killed by you, but he was anesthetized by other Delefs to later be awakened and moved to another location. His disciples would be taught to take care of the people elsewhere.

(Yes, this info of Jesus surviving the crucifixion, is in line with the old book, Talmud Jmmanuel, and the book [THE HERMIT](#), of LOBSANG RAMPA, "Jesu lebte in Indien" av Holger Kersten, "Issa" av Nicolaj Notovitj, "Christ in Kashmir" of Mohammed Yasin, and more. rø-comment.)

"I asked about all the miracles which can be read about in the Bible, waters that divide, locusts in Egypt and more." "It was the work of the Delefs, who tried to help the oppressed people."

(as stated in the book [Thiaouba Prophecy](#) from ca 1987, though not using exactly the same word for the cosmic helpers. rø-comment.)

I ask him why we can't get this help today. "Today," he says, "none of them remain with only signs and things they left behind."

"Where did they live?" I ask. "They lived between the mountains and in the sea. I have said that if you find Atlantis and the big caves, you will get answers to everything you wonder about. If you find them and interpret the signs correctly, then you have nothing to worry about." "We start talking about the annihilation of the planet of the Delefs, but there is not much to say, because he has shown me what happened. He just says once again, that we must stop before it's too late.

That's how we get back there. He asks if I'm hungry, because there's some time left. We go into one building where the interior is largely similar to an Earth restaurant. All walls are yellow, ceilings and floors are red, the small interior that is available is shiny as chrome, the

chairs consist of a seat and a tube and the tables look quite similar. We get food directly on a tray, the mug is the same as it I have seen before, but this time there is some completely colourless liquid in it, which tastes good, almost like a soda. The food is reminiscent of a large steak, but it is very porous in texture. I also get some salad. While we are eating, another man comes up and looks at me and wondering if he can get such a 'fire holder' as I have. I do not know what he means, but my host says it's my cigarette lighter he means, he saw it when I lit a cigarette. I give it to him, he takes it and goes and sits down at a table and tries to light it but without success, but I show him how to do it.

We leave the house to re-enter the craft and travel home to Earth. Then I ask the local animals that I would like to see. "We'll show you them on the way."

We lift and leave, but only a 20-30 meters above the ground. We arrive at the forest I have seen before, and he asks me to look down. I've seen a lot of animals before, but this breaks all records. The first thing I see is a large lizard of some kind, 8-10 meters long with all colours of the rainbow. It stands up on its hind legs and eats from a tree, and there are also other lizards in various sizes. A little further away I see something that looks like a cross between an elephant and a musk ox, also a very large animal. I also see some birds, but they look quite ordinary, much like our eagles, but with different colours. I ask if there are any fish in the water. He asks me to wait a while. Then he asks me to look down into the water, and down there I see one colossus that looks like a whale but much thinner, and so some other fish that are similar to sharks. I wonder if there are any small animals as well. They are, he says, but it is rare they show themselves, only the big ones are not afraid. He also says that some of them are animals that once lived on earth, and there are still some left. They hide away, but sooner or later you will discover them.

Now we are on our way to the Earth again, I ask how it can go so fast. He replies: "It is not as far as you think, but you can still not get here from Earth yourselves. You will eventually be able to travel to other places that are even further away, once you have left the earth. But do not fixate on the moon, for you will discover that it is doomed to fail, but aim further to Mars instead! There, the conditions are much greater to build intermediary stations, to then travel further and further. You can't come to us, but fairly easily go to others. And later repeated: start looking in your own history, and you will find the answers!"

We have arrived back on Earth, and I wondered if we would meet again? "It is possible," he says. "But if I want to contact you and ask for advice, what do I do?" I ask him. "Use the light and think of the star of the triangle, but do not use it unnecessarily." It was the last thing he said, and I was led out of the ship, and stood in my garden, and saw them off. The same thing happened again, four glowing orbs left the vehicle and hit the ground, where they disappeared. I went inside, my girl was asleep as he said. I glanced at the clock, it was half past five.

### **Spring meeting with the astronaut (29-MAR-1985)**

I thought that would be the last of my encounters with these strangers, but it has happened again and with the same nocturnal 'call' as before. Waiting to meet the craft, I am suddenly radiated by an intense light and find myself suddenly in there. I do not really recognize where I am at first. The room looks like a big bubble, and the aisle branches in two different directions upwards. The light changes from blue to green, then in the next second colourless. The funny little creatures are the same as before though, and I recognize the man as I usually talk to. I am asked to sit down on the surprisingly comfortable bench. I get a mug with some kind of drink, the same procedure as before being repeated. It's getting dark and I feel the vibrations. Apparently we're on our way somewhere. After a while, the room becomes bright and the tall man I met before enters. He sits down, and for the first time I see something resembling a smile on his face. I was going to ask about some things, but before I can do that he says he knows what I want to ask. I'm finding out that since we last met, he and his family have covertly studied me at a distance, without me knowing of course. His family? I think,

surely, it can't be those little ones? I get an answer immediately. The 'little ones' are their equivalent of our servants, and they come from a world many light years from us. They have suffered the same accident as the Delefs - and that can also happen our earth if we do not stop in time. He talks about explosions on other planets caused by what we call nuclear weapons, but thanks to the fact that some are far ahead of us in space technology, they can move to other planets before they are obliterated. Some of them have moved here, and others to other planets. Because I do not like either racial hatred or immigrant oppression, I have to ask him, about the status the creatures enjoy, are they considered to be some kind of slaves or the like? But he answers that they are what we would call his 'employees' to perform a job like any other job. The work done on this planet is similar to work done on Earth, with the difference that they get most of their labour from others planets. There are also people from the Earth working on his planet, some of them are traders. But he firmly denies that anyone would not be there of their own free will. I ask him how a man who has lived on earth for many years would choose to move to one place he does not know and leave family and friends behind and possibly never return. "You sign contracts with each other of the most diverse kinds," he says contracts with our so-called immigrants, but with the difference that they can be broken at any time. Let me say this: We make an agreement with you that you want to come to us for any year, and you accept the terms. You stay with us for a few years, but then want to return to earth. You are sent back and get a new identity, but at the same time you have forgotten everything you experienced, who you met etc. "I ask him how can that work, how can I get integrated back in with my friends and relatives after being away maybe for several years?

"I'll tell you how that works," he says, "but first I have some questions I want to ask you should answer as truthfully as possible. I already know your innermost thoughts, but I want to still see if I'm right." So he asks some questions about my personal circumstances, I answers as best I can. He thanks me for what I have told him, and says that of all who voluntarily come to his planet, no-one ever wanted to go back to earth.

I ask why I have not seen anyone but his people and these small creatures, when I've been to his planet before. "You've never been on our home planet. You've only seen one space base and a corrupted planet. But you'll get to see our planet, but it's a long way away. It takes six days to get there, and we do not know if you can do it until we give you a through physical. "Six days," I say, "it's impossible. I can't be gone so long without arranging that, and who is going to believe my reasons?" For the second time I see him smile. "Your time and our time is not the same. According to your time, you're won't have been gone more than 13 hours. "That'll be hard enough," I say. "I understand that you find it difficult, but your wife and children will sleep and not notice anything." But, they won't sleep that long," I say. "They can sleep even longer if we want them to." You mean you could put them to sleep without them suspecting anything? Is that what you have done before, when I have been away for short periods? "I can get them to sleep for the time it takes you to visit my home. When you return, you go to sleep too. Your wife will wake up first, then no one notices anything."

"To cope with the journey, you must drink about one and a half litres of a drink you will find in your study. It will make you both heavier and stronger. But make sure no one gets to see you when you drink it! You may get a little uncomfortable with it after an hour or so, but that will pass in a few minutes with nothing more than stomach-ache and a little dizziness. "One and a half litres, I'll never get it down." "You should drink some every day, half a litre at a time. A day or so after you've been drinking it, you'll notice you're your breathing is much calmer and you'll feel more grounded. "

"On the fourth day after you have drunk everything, if you don't find it too uncomfortable anyhow, you will find a small box with a steering wheel on it. Take it and turn it clockwise as far as possible! Then you should place it outside somewhere where it is not visible, but with the black side up. Now I'll leave you, but we'll meet again soon. My family is anxiously awaiting my return and hearing all about our meeting. They look forward to meeting you!"

A moment later I stand in my garden, to see his craft receded again up into the dark the sky. I ponder all that has happened. Can this be real, or is it a dream? I go in and lie down, but can't sleep, so I get up again and put on the kettle for tea. I think it's weird that I never even asked what his name was! Should I accept his offer to travel through space to his home planet? Or should I let him down and reject it all? No, I do not think I can do it. He has placed his confidence in me and he apparently trusts me.

### **Preparations for a long trip (27-April-1985)**

At last it's about to happen, what I have been waiting for several weeks! One evening when I come out into the storeroom (my hobby room, which he called a study) and open the cupboard under my work table, there is a mug and a bottle. I know it's not me who placed the mug there, even though it's one of my own. Next to it is a plastic juice bottle. In the mug is a piece of paper stuck down which I pick up and read. It is, so to speak, an instruction manual on how to behave. I will fill the mug with the liquid in the bottle, and then I will drink a quarter of its contents, then wait ten minutes, drink another quarter, and then the remaining quarters at ten minute intervals. When I have drunk everything, I am not allowed to eat anything for two hours. The same procedure is then repeated for another two evenings. It must be said that there was just no taste in the drink. It reminded me of water that had been left out in the sun for a few hours. In any case, he was not quite correct because I didn't get any stomach-ache or dizziness. But I did breathe more calmly and felt terribly strong and heavy. When everything was drunk, I took the mug and put it in the dishwasher. I tried to burn the bottle, but it turned out to be quite awkward. It became a lump that I put in the garbage bag along with other rubbish. When the four days had passed, I took the small box, which had also been in the cupboard in the Study table. I turned the knob as far as I could and hid it under a spruce in the garden. The next day and the following days I was so excited about what was going to happen that I couldn't settle down to do anything. I even reported sick at work and had to find some reason why I was home as an explanation to my wife. I went out and picked up the box again, which was still where I had placed it, but it was so hot that I got a blister on my hand.

A few days later I wake up at three in the morning. I get up and put on my clothes and go out on the main road. Under a street lamp some distance away, the tall man stands waiting for me. He asks if I have regretted it or if I want to come along. I explain that I can't come right now because of my wife and daughter. I don't need to say anymore as he replies that he knows about our routines in terms of work and school. We agree to meet in the meadow at nine the following morning. Then we part. In the morning after I had driven my wife to work and was on my way home, I see a person standing and wanting a lift. To my surprise, I see that it's someone I met on-board craft on previous occasions, so I stop the car.

He walks around and opens the car door on the right and gets in and sits down. I continue towards my home, but he says we should drive by and keep going until he tells me to stop. He indicates a meadow and we stop, get out and go out into the meadow. He tells me when I will be picked up and gives me a small box-like device that I will wear for a couple of days. It's no bigger than a matchbox, so I can easily have it in my pocket. Then he asks if I will bring some pictures of my family that he can keep. If all goes well I say and ask if I can get something to keep as a memento from his home planet. But he says that is impossible, because he does not want there to be any direct evidence of their existence - no physical proof. Not yet, he adds, so one day we will apparently be told that we are not alone here on earth. After ten minutes he says I should get in to the car, because he's about to be picked up. As soon as I've seated myself in the car, I see a large, almost oval ball that stops a few metres above the ground. In the next second he is gone, as the ball rises rapidly vertically upwards. Then it stops and makes a turn so that it is almost in front of and over me, and then slowly slides away. I start the car and drive home. When I get past the forest, I see it again. Then a light comes on underneath the craft, which flashes a couple of times. I understand that it's a greeting, so I flash back with the car's headlights. There is one more flash from the craft,

then it turns off to the east, disappearing behind some clouds. I'm driving home. During the day I look for some photos of my children and my wife as I promised him and put them in an envelope.

At last the big day arrives. My wife and children have left for work and school early in the morning, I feel like a child going on his first school trip. I eat a quick lunch, shave myself and put on clean clothes. I drink a cup of tea and have a couple of buns. Then I go for a walk around my house. I linger in my daughter's room for a while. I'm looking at her toys, and wondering if I should ever see her again. Same thing in my son and my wife and I's bedroom. I can barely hold back my tears. Now something strange happens, I feel stiff and start sweating. At the same time, I hear a voice that sounds far away telling me that I must hurry. Looking at the clock, it's almost a quarter to nine. I go out, take the car and drive towards the meeting place. When I arrive, the voice returns, and it asks me to go to the far end of the meadow. There are two people there, one is the one I met before.

The other is new to me, has a hood over his head, so I do not see his face. My friend - I call him that - says that this man will stay in my place until I return. "Why?" I ask. Don't be concerned, he is an exact copy of yourself, both in appearance and manner!" The man takes off his coat, I'm taken aback HE IS AN EXACT COPY OF MYSELF! LENGTH, BODY BUILDING, APPEARANCE, EVERYTHING IS THE SAME! But how can he pretend to me without anyone noticing? With my own voice he asks me ask about family, work, yes, about everything. I ask him if he's been to the Azores, and so on, ask what he did there and when it was etc. I ask him about my children and about all that I conceivable can. He answers all questions correctly! He says that all I can do, he can do exactly the same. In the end, I am convinced. He's wearing some sort of overalls, and I'll put them on. Yes, we should simply change clothes, even underwear. When we change clothes, he puts his hand in my jacket pocket and takes out the tobacco and the cigarette rolling machine. He rolls a cigarette, lights it and leaves - heading towards the car. I shout to him that I'll probably want my smoking stuff with me, but then my friend answers that I have all that in my pocket. And quite correctly, it's lying in there. The last thing I see from my copy is that he gets in the car and drives away.

Well, what's going to happen now? I wonder. "We wait until the bus has passed, then we leave straightaway!" Shortly afterwards, a bus arrives on the road, and it's soon gone. "Come on!" he says. Then I get to see that oval ball again, it is a few meters above us. In the next moment we are inside it. It is a single room with two chairs and a lot of instruments, everything is completely white. He asks me to sit down and lean back. For the first time, I feel that we move, it's kind of like riding a plane. There are no windows, so you can't see out. I have no idea how high we are, but we are hovering. Then he presses a button and points to some kind of TV screen. I get to see my car when it turns up at the garage entrance! My copy gets out and goes into the house. He comes back out again and into the garage, there he picks up a ladder. He puts it up against the back of the house and goes up on the roof near the TV antenna, where he puts a small box. Then he goes down and in again. Now both hear and see everything from inside the house on the screen, as clear and distinct as if we were there ourselves! He says everything is ready. To my surprise, he takes a pot of sandwich spread out of the cupboard and puts on water to boil. He opens a cupboard where we have bread, makes a couple of sandwiches and start eating. Then the TV screen goes out, and we are on our way again.

After a while, the screen lights up again, but it's just a dark field with a lighter dot in the middle. But as I look at the screen, the dot gets bigger and bigger, and I see it start to resemble a giant craft!

### **The visit to the home planet (03-May-1985)**

The large vessel is several hundred meters long. In the end, I only see one big black wall with one opening that we pass through. Suddenly everything becomes bright, it looks like a big hangar and there are already about ten of these bubble-like craft that I myself sit in. After a while, a door like opening opens behind us. We go out and towards a door that opens before

we arrive at it. We enter a long corridor and go through another door. . . We enter a large hall with a podium at one end and in front of it a lot of armchairs and people. I'm being asked by my friend to sit myself down. After a while, a man comes in and sits down at the podium. He welcomes us and talks about why we're here. We are informed that we are fifteen parsecs from the earth, are to be shown around their planet, to then return and reflect on what we have seen and if we want to come back again. Then he asks us to stay in our seats until we arrive. It takes about two hours, in the meantime we will get some refreshments.

Fifteen women now come in, each with a tray in her hands. One of them comes up to me and puts the tray down on a table. I get a mug of tea, two slices of bread with some kind of meat and something similar to our cucumbers. They are amazingly good, slightly reminiscent of the taste of kiwi fruit. The woman who brought the tray is sitting on a chair next to me and just staring at me. When she notices that I'm getting a little annoyed, she immediately looks in another direction. I ask her if it's okay to smoke in here, "it's okay", she says. She says that she does not know how to smoke. She's only seen people smoke on movies. She tells me that she has often seen films taken on earth, otherwise they would not have been able to learn our customs and our language.

I find out that we fifteen earthlings represent fifteen different languages, and that each of us have been given a hostess who learned the respective languages and studied the country in question. This seems like a pure tourist trip, I think. She says it's more of a study trip, because of the possibility of a later return trip and permanent resident status. I ask her where the man who brought me has gone. "He's gone over to another ship, but you'll meet him again." But this thing about becoming a resident, how will that work?" I cannot answer that, but for the foreseeable, you will stay with us. I'm part of your host family, you've already met my father. My mother you will meet when we arrive, and my sister you will meet later. We begin to talk about her home and what it looks like, and about their habits. She disappears for a while but comes just back with a pack of newspapers. They look like newspapers, but they are highly unusual. Before she shows me them, she tells me that they also have schools, although a little more advanced than ours. She says that they are probably five or six hundred years ahead of us in time.

"We have a topic that corresponds to your 'free choice', and there we get to choose what we want to do. Because I've seen so many movies from your planet, I chose to study an Earth human, I chose to study YOU for over 30 years!"

"Thirty years?", I say, how can that be? You don't look like you are older than about 30 years! I'm surprised when she says she's 53 years old. Her parents are over 90 years. "But still, I'm young compared to others. The average age for school is 58, and I'll quit when I'm 62" I wonder how she choose me out of all the Earth humans? "We get to choose any country shown on a map. I selected your country, because you had snow which seemed interesting, and I wanted a child too, as I needed a long 35 year study period. But that it became you I selected is actually a coincidence. I got to study a movie which was taken in your lowlands, it was bad weather, so there were not so many children out. The movie started down in Skåne and continued up over Blekinge and into Småland. After a while so I saw a lake, and on the lake some figures, so I asked them to stay there. There were three of you and had some kind of sailboat that was driven by the wind. You collided with the shore and fell and hit your left leg. I thought it looked so funny, that I said: I choose him! So now know how it all started! A few days after this happened, hopefully you will remember that a girl came to you and asked to talk to you for a while? That was me! Then I followed your life until now and will do so for another year. For soon, it is as you say, graduation!"

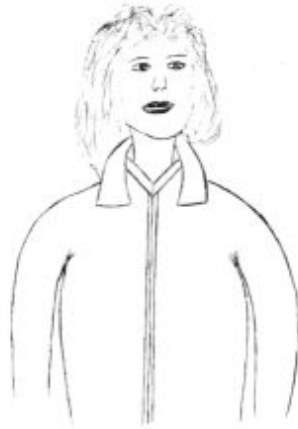

Now we are just around the corner, she says. "You must not be too disappointed by what you see, but you have seen that we are pretty much like you on Earth. In the city where I live in, there are no hi-rise buildings but only small houses reminiscent of what you yourself live in. Nature and atmosphere are almost the same. The climate is eternal summer, but with some storms. We have no cars like you, we ride about on small metal hover boards, for short distances anyway. We have lakes and seas, sand and rocks, yes, you can see for yourself that there is no major difference on our planets. The biggest difference is probably that you get to see a sun and three other planetary satellites that correspond to your moon."

"Now it's time for us to go to the smaller ships, because this stops here. On the way there, I'll show you what our planet looks like from here." We enter a room with bare walls, she presses a button, a window becomes visible in the wall, and outside I get to see a giant globe wrapped in cloud except in some places where there is a clear view. "Yes, but it's the earth," I say. "No, but I said it looked almost the same." After ten minutes, we have landed on what looks like one of our airfields, even though it is surrounded by contiguous buildings on all four sides. We go out, it feels warm and nice but much more humid than at home. She points to a small platform with two seats and says that now use this vehicle. It is a grayish metal disc, about two meters in diameter, 30 cm thick and with a ridge in the middle. We sit on the seats and she inserts a small tray that looks a lot like our credit cards in a slot on some kind of machine on a pole next to where the discs are parked. After a second, we lift about a meter from the ground and start sliding forward at a speed that I can compare with a car in city traffic. We approach a building that is long and low, and she draws out a new card when we reach a post just before the house.

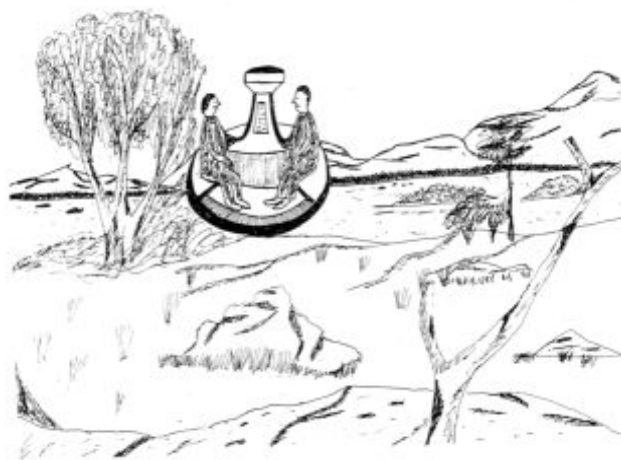

Now a gate opens and we go through. Outside it looks like a fairytale land, light green hills, shrubs and trees, but no buildings or roads are visible yet. In front of us is a mountain range, but it too is overgrown with grass and trees. It seems to be several miles long and a couple kilometres high. The speed increases slightly and we are soon up on the summit. The view I have can hardly be described, I must have ended up in paradise! Far down below us there is a collection of houses as well as in a valley in among the peaks. A river flows straight through

the whole valley, with houses on both sides. On the slope down, almost all the trees bloom in all the colours of the rainbow, and on the slope opposite are what looks like large vineyards. She stops the disc, we get off and she asks what I think. I'm lost for words I can't make a single sound. What I feel cannot be described, I shudder delight at what I see, but in the end I answer her that it can't be real. We step down into the grass, every blade of which shimmers. Do you think you could stay here and leave everything behind? I know you would like to, but can you? "Probably, if I had a friend", I answer.

"Now we have been up here, let's go down and introduced you to my family. We should also have something to eat and drink, because in not too many hours you will return to your home. "I look at my watch, and see its a few minutes past twelve. I will never sort this time out, I can't have gone that far in a couple of hours! Jenny says "If you had travelled with your Earth spacecraft, it would have taken over 110 years!" We sit down in the disc again and glide down into the valley. We cross the river to houses at one end of the valley, apparently she lives here. We stop and go inside. I have to say that it amazes me a little that everything seems so similar to our Earth. The house is made of wood and stone, the furniture of wood and metal, I see some yellow and white flowers on a table, I see a hob that is probably a stove. I am shown into a room that is almost completely in pink and blue, at a table sits an older woman, it must be her mother. I greet her and I'm asked to sit down. The older lady goes out, and my hostess sets out plates and glasses, but only for both of us. After sitting for a while, 'two little ones' come in, they look so funny I laugh. She asks me not to that, they get sad, they also have feelings just like us.

In any case, we eat a piece of meat and a lot of vegetables and imbibe a drink that tastes divine. When we have finished eating, they come in with a whole mountain of different fruits and more of the fine drink. When we have sat and talked for a while, it is time to go out and look at the surroundings with all its charming aspect and pleasing colours. We use the disc again for transport and go over the next mountain. Down below there is what I think is a big city, but that was obviously wrong - it is their industrial area. In some parts of this area, I am not allowed to enter, this is where they manufacture components for their ships and other machines. In other places, furniture, fabrics and things that are used daily are manufactured. I can see that there are some craftsmen who work with their hands, but most items are made in large machines, of a type where you put a tree in one end and get a finished cabinet out the other. When we have seen the manufacturing side of things, we go a bit further away, to a large farm where food is produced. There are cattle that are similar to our beef cattle and lots of birds about the size of our geese.

The cattle are allowed to roam in an area that she says is as big as Skåne and Småland together. But they are taken care of by the 'small ones', who make sure that everything works as it should. I wonder if it can really work, what if there is an epidemic of some kind? "It has been many years since the last epidemic raged, we have made sure that there can be no more." When we have finished looking at this, Jenny says that we will visit a lake where she usually sits and does her homework and where she writes down everything about me that has happened during the last thirty years. The whole time we have been together, she has looked at me a little strangely, as if she wanted to say something special. We ascend using the disc to continue over a landscape that I thought did not exist. We pass a zoo, she says that there are many animal species from the earth and also from other places. Now we can see a large lake appear in front of us. We descend to an island that is about a hundred square meters in size, we walk a bit and come to something that most resembles a gazebo. We go in and sit down at a large table. She asks if I want a cup of tea, and I say yes. While she picks out the obligatory mug and some rolls, I can't help but admire her. It feels just like when I was in love for the first time. Inside the gazebo Jenny has stored some magazines and books she has made at school. If I have not been shocked before, I am now! These books were about most of my life, with pictures and text. And what pictures! They were so life-like that I felt I could just pick myself out and put me on the table! I got to see my whole youth, yes, almost experience it again. But that was not the end of it, she also showed me a cupboard that she asked me to open. My surprise became even greater when I saw what it contained. On the top shelf was a



football with lacing. In front was a badge with the text: "Football used on June 6, 1956 by the object of investigation." Every single thing in the cupboard had to do with me. There was everything from toys to a bicycle that I thought was stolen from outside the garage at home one night. She says that it really was stolen that night, and also knew by whom, but she can't tell. In any case, it was stolen and thrown a few kilometres away.

When a whole month had passed and it was still there, she had picked it up. We sit for a while and talk. Then we go out and sit by the lake. She gets up and takes off her overalls. Shall we swim for a while before we move on? I am a little surprised by the offer to swim naked with a woman unknown to me, but she says that it is completely natural to swim without clothes, we have such strange habits and rules. Before we go swimming, we go into the house to wash ourselves. We stand in a box of some kind, and we stand so close that I can feel her skin against mine. She presses a button and it starts spraying water from all directions. I feel a faint scent of some flower, and at the same time I become slippery like an eel. After a while it sprays clean water, but so finely aerated that I can hardly feel it. When it stops, it starts to blow warm air like from a hair dryer. After half a minute we are dry and ready to go into the water, which is crystal clear and incredibly soft.

When we have finished bathing, we go in and drink a cup of tea and talk for a while. We go back to the valley and park the disc in a small square. Here there is life and movement, but none of the others seem to notice me. Around the whole square there are small shops and we go into one so I can see what it looks like. There's only one person inside running the shop. For every item Jenny takes off a shelf, she inserts a card into a slot. When she's done selecting her goods, we can leave without paying. How does this work now? My new acquaintance picks up a card and shows me. She takes one thing off a shelf without putting her card in the slot and walks towards the exit, but it remains closed. Not until she inserted the card did the door open. A very ingenious system! When a person has finished shopping in different stores, she can go to a bank in the same square. She then hands over her card which an official receives and puts it in a small device and presses a few buttons. Then the card and a small note come out. But no money is ever seen. "We do not spend money, we trade with time."

- "Time?" I say.

"Yes, let's say you want to go out and buy what you need and want. You get so-called bank statements, but it does not say sums of money but how long you have to work in the fields or in the industrial sector.

Every small town like this is a collective for itself where all the food and other things you need are produced. You do not have to work for more than one, sometimes two days a week to make ends meet. But some industries own all the cities together, and there you have to work three days a month. If I want to go and study the planet Earth, then I have to work about three weeks in the common industries to earn as much energy as is needed for a round trip Earth." We leave the square to go to her house and get some food, it's starting to be time for me to return home. At her home, a real feast is on display. While we eat, I get the chance to tell Jenny a bit about how we live, but I soon gather that they already know most things. One thing, however, she can't understand, and that is why we can't remain at peace but have to keep on fighting with each other. "Did you not receive a warning when the first atomic bomb was dropped? If you do not revolt against the war-mongers now, you and your children and grandchildren will experience horrible things, eventually to finally cease to exist. Your planet will become a ghost planet, and such there are already too many of them. Try to make people understand where they are going! You have seen what happened to the Delefs, and others have also seen it.

I say "But it is difficult for a few people to influence the rulers so that they retain their reason."

"We also have governing bodies, which is equivalent to what you call the United Nations. Although the governing body is not here but on one of the other 18 planets. We must not

intervene. We have tried to contact you on several occasions, but you constantly rejecting us. If you have seen us, you deny we exist. Or you have simply tried to neutralize us with your weapons. But you do not succeed, because if we wanted to, even though we are against all that is called violence, we have weapons, a long time ago weapons were used for war even with us before we regained our senses. Nowadays we use our weapons only for peaceful competition and, for example, to destroy what you call garbage in space."

"But we have said, come the day you stop using nuclear weapons and the like, then we will show ourselves to your rulers without being rejected. It has even gone so far that some of us have been captured by your military and imprisoned, for them to be silenced and forgotten. But we have brought them home.

Many authorities already know that we exist. But they do not want to publicize it, according to what they say it would be chaos if the public found out. But it the real reason is that they are afraid that we will take over and that they will no longer be allowed to rule over you. They also believe they were created to rule over the whole universe, because nothing would be as superior as man. But they do not know how wrong they are, because you are not eminent compared to races on other planets." We have finished eating and have to leave. "I hope you had a nice experience and I wish we could meet again!" I get up from the table and thank Jenny for a delicious meal and talk about how nice and wonderful everything has been, just a shame that it was such a short time, I would have liked to stay longer. "You are welcome to come back whenever you want, and the offer you received will remain as long as you live!" We go out and sit on the disc, which lifts slowly and slides away. When we get to the top, we stop for a moment so that I can see this paradise one last time, before it carries me home.

"We chose this day for you to see when the sun and the planets rise." -"When the sun rises up?" I said, "but it's been day all the time!" I get annoyed when she says that this has been their night, that's when most of the work and the like is done. "During the days we rest, because it's too hot to do anything then, it's getting up to about 50 degrees centigrade hot!" "Yes, but, when do you sleep then? "

- "Once every five days." I say that I'm finding it all very difficult to comprehend. "Now it's only a couple of minutes to sunrise, you first get to see an almost completely green moon, shortly after comes the sun with its yellow-red glow, and a red moon on each side. What I now get to see is so amazing so I don't know how to describe it. I don't know what's bothering me, but I grab her and hug her for a long time, and she does the same with me. The green moon lights up the whole valley, and when so the sun and the other two moons come up, it is as if the whole valley is bathed in a shimmering lustre of the most beautiful colours. It is incomparable! We probably stand for ten minutes and hold each other without saying a word.

Then we went down into the valley and into the airport, from where one of those smaller, round craft takes us up to a large spaceship. When we get on board we have to go into the same room as before and sit down. Then that man who I now know is her father came and asked if I was happy with what I experienced. "I've never been so happy and content," I said, "it's just a shame to have to leave this paradise after such a short time!" I was told I was welcome back. "You know how to contact us, when you feel like a new visit. I'll leave you now to prepare for the return journey. I hope we meet again! That was the last I saw of him. Then a couple of other travellers arrived, probably from South American countries, from the sound of their language. After a while, my adorable hostess comes to me and asks if I want something to drink or eat in the meantime. I get a cup of tea and she sits down so we can continue our discussion. "This longevity", I ask, "How can you get so old and still look so young?" She says that her oldest relative is a little over two hundred years old and that she is probably good for another hundred years or more. "But those who come to you from other planets, how is it for them?" She says that everyone gets the same opportunities and benefits as those who are born on her planet. "They have to undergo an operation when they get used to the new climate, also they have to be here for a year or so in order that we can see that everything is working properly." We talk about their 32-hour day and much more, and soon we are back in proximity to the earth and the craft has stopped. We go to one of the small

'bubble-craft' to actually go down to the Earth. "Why can't we go down with this big ship?" I ask. - "It would be discovered right away, it's too bright. We've landed with it before, which was discovered, although your authorities have pretended otherwise." We're just landing now, and she switches on the screen. We can see how the ground approaches quite rapidly. She presses another button, and now we see pictures from inside the house where I live! My replica is sitting in front of the TV watching music shows. She presses another button and immediately my copy stands up saying he is going to the kiosk and buy tobacco and that he will return soon.



We land behind a large tree and walk downhill to wait for 'my replica'. When the car comes, he steps out and walks towards us. We exchange clothes again, then he steps into the bubble-craft. We are standing left alone for a bit and look at each other. Jenny grabs me, and we give each other a farewell hug. She goes to the craft too, I know she'll be gone a moment. I see when it lifts, a light flashes on the underside. I stand for a while and think about what happened. Will I ever meet them again? I take the car and drive Home. When I arrive, I see that the small box next to the TV antenna is gone. I go in and sit in front of the TV as if nothing had happened.

*Image for illustration only*

### **Return visit to the home planet (11-June-1985)**

On the morning of June 10th at 6:45am - after my wife had gone to work the phone rang. When I picked up the phone, I heard a voice asking "What did I want?" - I didn't really understand, but who would? - "You called me!" I got a little annoyed and asked "Who is it and what did she want". "You can call me Jenny, and you called me last night. "At this point, I thought I recognized the voice, it sounded like the woman I had visited far out in space, and quite right - it was her! "How in the world can you call me here? As far as I know, I did not call you, but when I was out last night, I thought it would be fun to meet you again. I would like to know a little more about your home planet before I can decide if I want to relocate permanently. "

- "Can you be ready to go with me in 30 minutes?" When I had recovered from the initial surprise, I answered yes and promised to come to our latest meeting place. I called my workplace and asked for time off, then I got in the car and left. Once there, I parked the car so it was partially hidden and waited. I clicked on the car radio and listened to the music. Suddenly it stopped and I heard her voice on the radio instead! I was asked to come out now. I got out of the car and came around the back where it was unobstructed, I could see where the egg-like vessel stood or hovered, and she stood outside it, Jenny the space woman. When I walk up to her, she hugs me and we go into the craft. I ask if I don't have to go through the same treatment as the last time I travelled. IE the procedure with the drink. "No, what you took then is enough for five months - so you can manage fine without for a while." I ask if we're on our way to her home?" If you want to, I'd be very happy. I've actually missed you a lot since we last met, but I didn't want to get in touch with you, so you could think about our meeting in peace and quiet." I say I have thought over what I have been through every day but find that I had neither the time nor the desire to makes sense of it. But I have also become calmer and more harmonious than before. We're talking about the strangeness of life, including some strange experiences I have had, and very soon, we are at the big ship that would take us to her home. This time I don't know if I am the only Earth resident on board the

ship, because we sit in a smaller area than last time. But I also get tea and bread now. I say I hardly think I could leave everything at home behind me and settle on her planet, although it feels enticing at times." I understood that from the beginning," she says. "but I wanted to offer it to you anyway. I would not be able to leave my home either to move to another location. But if you are interested, I hope you can continue to say hello to me, for you should know that distance does not matter. And would you feel discouraged and downhearted you can call me, because I'm always here if you want someone to console you. "

- "But it must cost you a lot of work to take you home to me, and besides, I have I have still not figured out how to call you! "

"If you promise me not to show it to anyone, I'll give you a small device you can contact me on whenever you want. You will receive it and an instruction on how to use it, it's a kind of radio communication device so you can even talk to me through it. And as for the cost of picking you up, it does not cost me more than it does for you to go by car a 30-40 miles. It's such a small cost for the joy I feel when I get to meet you. You have, as it were, become a family member throughout the years I have studied you at school, and when it was decided that I would meet you, I was completely dumbfounded with joy! Imagine meeting a person who does not know about our existence at all or that there were others apart from themselves in the universe! I was both curious and excited before the meeting with you, so I did not work properly for several months after I was told you would be asked if you wanted to come here. And I almost thought it would fail when I got find out what happened to you that nasty winter night. But as I explained before they behaved clumsily to say the least. We had to start all over again and take it step by step, so that you would understand that we did not want to hurt you. We could never make you or your family do something against your will."

"I will instead warn and protect you from threatening dangers that you may be exposed to. Whatever your plans, do not move away from your homeland, they and some other nations are the only countries that manage reasonably well with the war that will break out if you insist on the foolish nuclear weaponry escalation that is going on. Sweden won't get directly involved in it, but you will feel the effect of it, with rations of various kinds, and also in terms of energy you will be affected. You will be forced to receive a large influx of refugees - starving people - who have been unjustifiably affected because some do not want to realize that neither of the two great nations will win by starting a war of annihilation." I ask her if they could do something to prevent that from happening? "With your knowledge and your technology, it would not be so difficult to put a stop to it, and there are other things that you could help us with. You could warn us of disasters of different kinds and help us do something about the famine that prevails in large parts of the world, not to mention all the environmental degradation of our nature and our water!"

"I can most easily answer that you have to learn to take responsibility yourself. Should we intervene and cope with your difficulties for you, then you will know that it does not matter what you do, because we are behind you and will help you if things go wrong. Look at a social case, he does not have to do anything, just go and get help from the social services office, when he is unable to pay his rent or food. Where would it would end if people did not try to solve their problems themselves?"

"All these billions that your military costs, why don't you take them and use them to cultivate large desert areas and build irrigation systems and bigger and better treatment plants for your industries? Then you answer well that in that case there would be great unemployment. But that would not be true at all, it would instead provide jobs for many people for generations ahead. You would see that your crime would also decrease more and more and eventually disappear completely, and even the abuse of alcohol and drugs would eventually disappear. Sure, it would take a generation or two, but would that not be something to strive for? You I still want your children and grandchildren to feel meaning and security in life, without have to go and worry about the future!"

"Now I can reveal that we once had the same problem as you. We were also a warrior civilization, but the people eventually understood that it was not right. They then took the matter into their own hands, organized themselves and took power themselves. They destroyed all the weapons and the factories where they were manufactured. It took many years to put everything right, but they succeeded and also carried the rulers with them and made them realize that they were on the wrong path. As you know it didn't go as well for delefs, more than half of their planet became uninhabitable and the rest not much better. Those who did not escape to nearby places had to starve for many years, they lived in caves and fed on what they could grow and caught some wild animals, yes, and they lived as ancient people."

By this time we had been standing still for a good while, so she said we would take the smaller craft and go down to her home and get some food and then take a bath at her island. Bathing I understood that they did quite often, because we did it several times this day. When we had eaten and drunk that heavenly drink, she picked some fruit and put that and some drinks in a basket that we could easily take with us to the island, because we were supposed to stay there the rest of the time before I would go home. It was when we got to that square I mentioned earlier that I was really shocked. There stood another woman and a man who were apparently waiting for us. It turned out that he was Danish and that he had received the same offer as I, with the difference that he had accepted to stay there. He told me that he had been there for over four years and that it had happened about the same as with me before he got there. However, he didn't have a family, his wife had died six years ago and they had no children, so he had never hesitated to move. Nor had he regretted taking this step.

"This is probably the closest thing to paradise one can get! Three times since I came here I have returned to Denmark and visited, and no one has known where I have been, because I have told my friends that I have moved abroad." We talk for a while during which time the women do some errands. I find out he's an artist and that he sometimes helps on the large farms. He is 38 years old and lives with the woman I just saw. I ask if they have any children, but they have not yet got one yet. "Does it work in the same way as at home or in some other way?" I ask. He chuckles and answers that there are two ways to have children here, either in the usual way, or you can buy a test tube child from a laboratory, it is the woman who completely and directly decides that matter. I do not have time to ask the next question until he answers that it is okay to love her whenever you want. No protection of any kind is needed, because she can control her body so that she is not receptive until she herself wants to have a child. He wonders if I'm going to move here or just be here to visit. No, I'm visiting, I have my family to think about. He also points out that I have a faithful friend in Jenny, who I should place my trust in. Now the women are back and we leave on the disc that I described before. We come out to the island with the little gazebo, it feels like I have never left this place. Inside is the cupboard with my things from the past, and on the table is a photograph of me sitting on the beach outside completely naked. "When did you take that photo? I never saw you take it."

- "I took it when you were last here, you're not angry about it, did you?"

- "No, but you could have told me, so that I had the chance to fix my hair a little!" As it looked there, it was like a dog had licked me on the head. When she has prepared the fruit basket and drink, we undress to bathe. We go out in the water a bit, because it is quite far to the deeper water. I look at her body and I see that she notices it, but she just smiles. I'm normal and can't help myself watching. She makes me feel like a teenager out bathing with her girlfriend. When we have splashed around for a good while, we get up and enjoy the fruit that she has set in the little gazebo. Then we sit and take turns talking. I can't stop thinking about what Jenny told me on the way here, about the imminent danger of war we are in. I ask her if she can say in any more detail when it might be that this war would break out. "I can only say, that if you do not end your efforts to invent various weapons of mass destruction, you will not see your grandchildren."

"So you mean we will have a war on earth in the next 20-30 years?"

"No," she says, "a war can break out at any moment, but do not worry your own part, your country will not be drawn into it, but as I said before, you will feel its effects in different areas, and you will also receive a lot of refugees."

- "Yes, but you can tell me if there is something I can do, or do you mean that I just to stand by as a spectator and cheer on the best team? Shall I go out and tell this that I have been told by you? If so, who would believe what I say? I have no proof of your existence!"

- "If you talk about what you have learned, you will see that you will get millions of people on your side."

- "I have been thinking of publishing all this that I have been told in book form."

- "Yes, it is a good start, because it is appreciated by all those who want an end to military rearmament. But you should know that you will get a lot of resistance as well. But you will be helped by those who believe in you!"

"But won't I get the church and the religious fanatics after me to, if I speak to the public with the 'deviant' view of Jesus and his heavenly Father that you have shared?"

- "You do not have to worry. Ask the religious to produce a single piece of evidence that God and Jesus exist, they can't! You know what they call Jesus, he was a delef and he's been dead for many years. That he was perceived as a "savior", that is the people's own invention! If you were to write down everything you know about us and it was then saved for thousands of years, then those who then read it would also claim that we were gods. There may not be anything really wrong with that belief in something you call your god, but it would not be better to believe in yourself and your own future?"

Eventually we get up from our meal to take another bath. I find that there is a lot of people on a nearby island, and I also see a sun that I did not see before the time I was here, because it was at 'night' when we bathed. "Today is a day that corresponds to your Sundays, so no one does any work. Everyone wants to be in the water most of their free time. Mostly because it is so hot during the day, we are most active at night, both when it comes to leisure and work. But we also want some sunshine in our free time, so the sun you now see is artificial. "Now it's time for us to leave, so we get dressed and pack the rest of the fruit in the basket. We sit on the disc and glide across the water, which is something incredibly clear and clean. She asks me if I have enjoyed the visit and all that it has entailed. I answer that I wish it was not the last time I get to visit her, even though I do not want to move over here at present. "You are

welcome just when you have the time and desire. From now on you decide when you want to come here." On the journey home to earth, we talk about man things that I don't write down but preserve in my memory. I understand that they are not evil beings, and I am happy for.

*Illustration not from book*

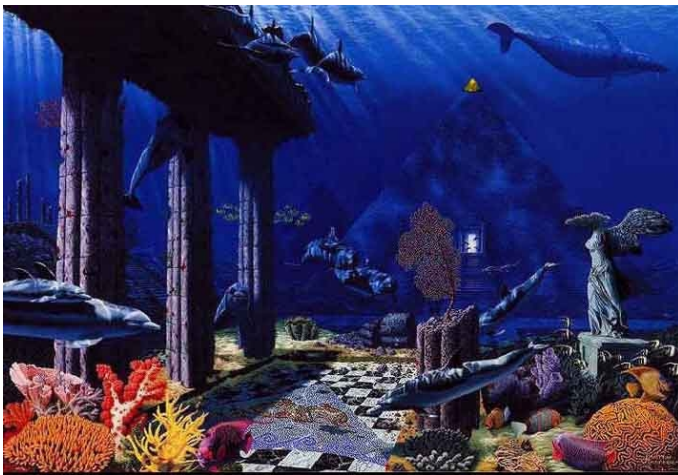

### **Visit to the seabed (22-July-1985)**

It has been a while since I have had any experiences that I have been able to connect to my earlier experiences, but the night before Sunday, something very strange happened that I

have hard time explaining. I was woken up by someone or something who told me to go out and sit my car, to start driving and that I'll receive more instructions while driving. I did so and ended up somewhere between Urshult and Ryd. I parked the car next to the road and walked a little piece until I stopped at a pole (of stone I think) in a small clearing.

When I have waited for a while, I see a flash above me, and I get to see the "egg" again. It lands behind me, hovering just a bit above the ground. Just when I'm going into the craft, something strange happens. A car can be heard in the distance and its headlights illuminate the entire clearing, so I say to myself that now they must see both the craft and me. But what happens? I turn around to the craft only to discover that there is nothing there! But once the car is gone, the craft is back! I go into it, sit where I usually sit, but the man sitting in there just in front of me mutters something I don't catch, then we head west at quite a low altitude. When we have flown for a few minutes, we arrive at some open water that must be the sea.

After maybe half an hour of flight the craft goes even lower, and I see some light shining up from several boats, both large and small. Now we can't fail to be discovered, I think, but for the first and only time during this journey he says something. "What you are about to see, no man has seen for thousands of years!" Shortly afterwards we go down into the water and disappears into the depths! After about five minutes, I get to see something so amazing, that it can hardly be described in words. It looks like there was a whole city underwater, there were strange buildings I have never seen before! We hover outside something that looks like big hangars, and on these there is something I have seen in previous experiences, large shiny spheres, which sits on some pillars on the roof. The pilot exits the craft and goes to the inner wall, a previously invisible door opens and closes behind him, and a moment later I see him on his way - through the water outside, into one of the hangars! I myself sit and look



out at all the strange things. I see a person who swimming out there, without any SCUBA equipment! Some fish - big and small - also swims by my window. A bit further ahead I see a person on guard, he holds a rod with a ball on it and is standing completely still! I look through the pilot's window and then get to see something which makes me nod it is so fitting. The place where we stand is paved just like our old streets were, and a bit further ahead to the left are three pillars and crumbling masonry reminiscent of a temple ruin from antiquity!



I happen to look a little at the pilot's dashboard and then see some kind of maps, but without any place names or labels. It is now that I get the idea to try to draw one of these maps. I have prepared myself for experiences like this a little more than the last few times, so I have a pen and a small pad in my back pocket. I do not have time to draw much until my pilot is back again. He has retrieved a box of some kind. He opens a hatch in the floor and takes out a similar box, replacing it with the newly acquired one instead. Then he goes out with the displaced box and is gone so long that I have time to draw one of the four maps that are at his station. Now he's back again, and we're on our way up to sea level. Once up, I see a large ship 700 - 800 meters further away, and then we disappear up into the night sky. I do not see much more than some light under me. After a while we pass a city, which judging by the number of lights must be quite large, the remaining time I see only scattered light a little here and there. After a while we lower ourselves to a height of a couple of hundred meters, to finally stop in the clearing where I was picked up. Soon I am standing out by the stone pillar again and see when he leaves in the night darkness. For me, all that remains is to go to my home and go to bed. In the near future, it feels like they are keeping me under surveillance in some way. I think I hear an inner voice that warns me of something.

The phone has rung a number of times without someone answered at the other end, but I have heard faint sounds as if someone is breathing. And the TV has behaved strangely for several evenings, after the last program it is as if a figure appears in the TV visual static that appears prior to close-down for the night. I even woke up at night as if there was someone inside the room, I see no one but can hear the same faint breathing as in the phone. It's like someone's standing right next to me. One night I have several strange dreams, among other things I dream that my family and I are floating some hundreds of meters above the ground, enclosed in some kind of bubble. I notice that my children have gotten older. Suddenly a large flash of fire appears on the horizon, and then a long series of explosions is heard. There is more fire-fight flashes, after a few hours it become completely quiet and still. We start to move in the direction of the place we saw bombarded, and when we arrive we see that everything is ruined. The people and remnants of houses lie on top of each other, it sprays water up from the ground and fires burn and smoke everywhere. We are a few metres above a large street that is torn up here and there. A bit further ahead is something that looks like a billboard and the text on it frightens me. It says: 17 June 97 at 07.13 + 16 °. Shortly after, I wake up.

One morning a couple of weeks after my visit to the seabed, I sit and eat my breakfast when I suddenly hear a voice inside me saying that I should go out into the storeroom before one happens accident. I do as I am told, and if I had not done this, who know what would have happened. I probably wouldn't still have my home today if I had not listened to the voice. The fact is that the night before I had sat there and tried to solder one brake wire for a bicycle without success and forgot to remove the wall socket powering the soldering iron. If it had caught fire, there was about 15 liters of thinner in the storeroom in a plastic can and a lot paints that in a few minutes could have turned the whole house into a nice bonfire. The only damage that actually occurred was that some wooden slats were charred and a large one



burn mark appeared on the workbench plus a lot of eye-stinging smoke. When I've put everything right, I go out and finish my meal and think about what might have happened if I had not been warned. I think about where the voice came from and it reminds me of a previous meeting I had with my 'friends from elsewhere'. They promised me that nothing bad would happen to me or mine. So the only thing I can do is to express a warm thank you to the person or people who are watching over me!

### **Meeting with scholars from space (December - 1985)**

It's been a few months since I met my friends from elsewhere, but now I have been contacted again and have agreed on a nocturnal meeting at a lake north of my home. I go to the meeting place well in advance and sit and wait on a log near the barbecue area by the beach. When the woman arrives, she is not alone but in the company of two men who are unknown to me. They look a little different from others I have seen before, are quite short, but have long arms, hands and fingers and at the far end of the fingers where our nails are they have round and flat fingertips. Their legs are narrow and they have some kind of shoes or boots, bluish in colour. The head is slightly oval, they have a small mouth, large round eyes, narrow ears and small, flat nose. On their upper body they have a tight blue-green knitted top, quite shiny, and a belt with two white triangles and a square. I also see a sign consisting of two interconnected circle segments, one green and the other blue. I ask who they are and where they come from. The woman answers that they come from the other side of her planet and are scientists. Of course, I wonder why they want contact with me, and one begins by telling about things that have happened in history.

"Thousands of years ago - when we had come so far with our technology that we could start exploring the universe - we made trips to many places, even to your planet. We waited long before we decided to contact you, but then we made several attempts, unfortunately not with particularly successful results. It has happened that we have been mocked and persecuted and even executed because we wanted to help you. "

- "What do you mean?", I say. "A long time ago we tried to teach you what was right and wrong, we helped you to make certain laws, remember the ten commandments that we gave you! What has happened to them after all these years? Have you understood them and lived by them? "

- "So you mean that it is you who have given them to us? Is it also true that the person we call Jesus was one of you? "No, he was a defef who came from our twin planet, where his father was a doctor, but there was more than Jesus who appeared on earth at this time, Mary was not the only woman who had a son from us. There were exactly 17 other women who had sons by our ancestors. But it was only Jesus who was remembered because he managed to get a crowd that believed and trusted him, the other seventeen were not so memorable - not get to any great extent. They became expelled and mocked, so they were eventually brought home to the place from which they came. "

"But why could you not simply show yourself and make yourself known, without having to start from a newborn baby? And so Mary conceived in the usual way?"

"Yes, Mary and her family were not earthlings, they were simply brought down to earth by us, and she was already carrying the child who was called Jesus. They were, so to speak, deployed on Earth in such a way that no one could expose them, and the same thing happened to the other seventeen. If you believe something else, it is wrong, but one day both you and everyone else will find out the truth, and then you'll also understand that you are not alone in the universe. We can't reveal the whole the truth about your origin right away, because then it would be complete chaos, but you do have one or two building blocks over the years that you can research further from. When you have arrived far enough you will probably understand that you are not created by any invisible being. Many of you by the way,

have already begun to realize that God did not create the world but that you are descended from another civilization far out in the universe."

"As I said, we have shown ourselves several times, but your so-called leaders and governors do not want you to take us seriously. They're trying to explain us away as being a fantasy, as not existing, as they believe that we would take over your land and demote them down to ordinary citizens like yourself. But in our opinion, it is you ordinary people who have the easiest time taking us seriously, so therefore, we have decided to make the first contacts with you, not all - but some hundreds of you. When you feel that the time is ripe, you will influence your leaders so that they too understand."

"You know why you have become one of the chosen ones. You and some others have not tried to deny us, even though you did not take a stand on our existence until that day when you were all simultaneously reminded that we exist. We can only regret that it went a little clumsy for some of you, but from what I have heard and seen, you have not taken any damage, on the contrary. Instead, you have become more confident and mature than you were before our first meeting. Perhaps even more important is that you have become one with yourself, and that is more than others ever will be. You will notice it when you are eventually confronted with everyone trying to persuade you that all this is a collection of fantasies and dreams. You'll also meet people who claim to be experts in everything concerning us and our movements, but you should notice that they don't have the slightest idea what it's all about."

If we are going to talk about experts, there is really no one other than you and your friends we contacted, you are the only ones who know us." And now to the big question. You have been asked if you want to come to us, but you neither answer with a point-blank no, but you don't reject us when we visit you. Instead, you called us at different occasions to help sorting out certain things. We have said we will help you, but not so much at once that it attracts too much attention, but we take it a little at a time. Have you thought about what it is we want from you? We want to work with you, and if you are prepared to continue our meetings, we promise to stay in touch for as long as you want. "But why can't you make yourself known to much more than just a handful of people?"

- "As I said, we have tried to get in touch with you in a low-key way, but in case of massive contact, we will be attacked by your militaries, who for some reason do not want you to know that we are available. We have no plans whatsoever to start a war, we only have peaceful ones intentions. But as long as your authorities do not accept our existence, we can't help you possibly before it's too late." I say that if they are really willing to help humanity to prevent its own self-destruction, then I'm willing to provide whatever help I can. "You certainly could help us with one thing or another, "he says," for example with observations of various kinds. As you see, it's a pretty costly procedure for us to get here and just as costly to take us back, it consumes terrible amounts of energy. If you want to cooperate with us, then we will be happy to give you both training and provide you with suitable equipment that you can use for future missions."

"When and where will you show yourself to the people of the earth?" I ask, "so everyone will get to experience your existence?"

- "When that day comes - and it is already decided by the way - we will show up many places at once. We know it will cause some concern, but with the help of you and your friends you will find out in good time so that you can make some preparations. Then it will go a little easier. The big question is how you as a whole will react to us, because as you know there are quite big differences in appearance with us. But like yourself once said, it is not the exterior that one should judge by, but what is inside. You'll have to just accept that everything works out in the end, and sometimes it is quite pointless to try to solve some problems." While we sat and talked, we ate some fruit and bread and drank their good drinks. Suddenly the two men get up and say that it's soon time for them to leave me, but that I might well have something to talk about with Jenny. Jenny and I sit for a while and talk over what the two men spoke about. Of course, I'm curious about what's going to happen at a later time, so I ask her

what it's about. She says the different places I've been to will be my so-called field of work, if I agree to work with them. And provided I'm willing to do so and it does not interfere too much with my work and that my family does not suffer. After all, no human has shown such great respect and understanding towards me throughout my more than 40 years of life as they have done. Anyway, our paths part here this time, and I've been told we will not meet in the same intense way in the near future. But we will keep the contact in the interim. The last thing that happens is that we hug each other for a long time. Shortly afterwards, she is on her way into her egg-shaped vehicle to disappear across the lake. I stay for a long time and follow them with my eyes until they are gone. In the name of honesty I can't say that I see too much of them, because my eyes are pretty teary. Is this the end of a long-time friendship, or will I meet her again?

### **I get an explanation (31-June-1986)**

It's been a while since I met my female friend from elsewhere, whom I call Jenny. When I now see her again at our meeting place, it's already summer. I say I have pondered so much on how it really went during that first contact with them that was so violent. "I understand," she says, "that you have not accepted my previous answers to the question of what happened that winter night just over two years ago". I answer that I probably would have accepted the answers I received, but something more must have happened - it just does not make sense time-wise.

"From the time I first discovered you out in the meadow until I was picked up by the police, it must have been several hours more than what calculated later. But if so, the only solution is that I must have been on board the craft for well over four and a half hours. I've had my suspicions but not been sure, so I did not say anything to anyone. Those guys who talked to me about what happened, they have several times asked me if I wanted to undergo hypnosis to possibly get more information, but so far I have not wanted to agree to it.

In fact, memory images have begun to surface in my consciousness awareness of my stay inside the craft, and I have wondered what caused the red and blue rings on the body and why you cut some hairs and put them in a jar with water or similar, and finally why you took one of my slippers and cut off a piece of the rubber sole that you then melted? And then I wonder what happened when I stood inside the plastic-like box that was like a sauna. I've heard of others who should have been abducted and examined and even operated on by extra-terrestrials. Was it something similar that I have experienced?"

"As I told you before, it all went pretty awkwardly when you were invited to our ship and our world. After you left your friends, we expected you would stop and get out of the car to look a little closer, which you did not. Instead you went home to get your camera, which we guessed you might do. So we decided to wait for you in the same place you first discovered us. But certain circumstances meant we could not remain in the same place, but we decided to move a bit north. Where we were in the first location there was a great risk that we would be discovered by someone else, not good. Anyway, we saw you come and stay for the first time instead. Do you remember thinking about turning around and going back? But with a little of our art as you call it, we made you continue a little further so that you would see again U.S. We had another little problem and that was how we would make you not be afraid when you discovered that you could not drive past us.

Had we suspected that you would be so scared, we would have tried in some other way, but we had studied you so long before then, so we did not expect the fear you felt. When you were picked up from your car, you were so shocked that you did not really know what you were doing. You started beating around with such force that you more or less injured one of them our guard so badly that it took a long time until he was fully recovered. But in the end you went quietly with the others into the ship. Once you got in, you were pretty beaten up, so we gave you something to make you feel better. Shall I be really honest with you? were so

shocked that your heart had more or less stopped. That was why you got these rings around your chest and waist and were placed in the pressure chamber. "

- "So the rings are something similar that we use in cardiac arrest then? But the pressure chamber then, what would it be good for? We probably only use that to help divers when they have been down at too great a depth!"

"Yes, of course we also use a form of electric shock, but at the same time the pressure in your body must be restored. When you get cardiac arrest, your blood pressure also changes, and it must at the same time be restored to normal. It is a mistake you make with cardiac arrest cases that you only give an electric shock, but combined with a pressure chamber and rapid heat you can help even difficult cardiac arrest patients to survive."

"And the hairs we took from you, they are used to easily determine age and gender, your gender we already knew of course. "When I ask her about the piece of rubber on the sole of slipper, she starts to laugh and says: "It was not your shoe sole we were interested in, but we took a sample of your skin from the bottom of your foot to see what condition your body was in. The skin says a lot about your physical condition, and even some details of your psyche."

"Actually, you were supposed to have accompanied the guards to another ship that was waiting nearby. but unfortunately we were spotted by another car heading south, so we chose to drop you off. Since we knew you would be taken care of, we gave you no in-depth treatment - It could have been discovered on close examination. I have to tell it as it is: It's lucky that not more of you are sick and ill, seeing the primitive treatment you get in your hospitals. The examination that was done on you afterwards was so cursory we could easily have given you greater treatment."

"Yes, now you know what happened at our first meeting, and you have not taken any lasting damage. Have you received answers to your thoughts, or are there any further questions you'd like answered?"

- "I can't think of anything at the moment, but I will probably ask more questions in the future if we continue to meet, which I hope we do. What makes me a little sad is that we can't meet more often, but I understand that you have to have other things to do than visit me."

- "Yes, unfortunately it is the case that our meetings will be sparser in the near future, but have patience!" I explain to her how difficult it is every time we part, and it takes several days before I can think of anything else, before I can stop thinking all the time about all that has happened to me. With those words, we say goodbye for this time and I hope to meet her soon again.



*This picture not from the Ante book.*

### **A mysterious visit to New York (20-Oct-1986)**

One of the strangest things that I've ever known, now happens to me. Visions or pictures appear out of nowhere, and shortly afterwards I find myself in these pictures! Like a couple of days ago, one night at 9 O'clock. I had gone to bed to rest - when one moment later a turquoise cloud or fog suddenly covers the whole room I am in. My first thought is that now Jenny is here, but there's no sign of her. I sit up in bed. For a brief moment, everything appears black, but after a while it becomes brighter and weirdly cool. I begin to see a picture appear in front of me, but it does not stop, but it sort of engulfs me, so that I am simply in the picture, sitting on a bench! When everything is clear, I see a lot of tall buildings around me. I'm in one big city that turns out to be New York in the early morning! It must be a few degrees minus, for before me a gentleman is in a frozen pool of water. But it does not look like anyone notices me, the people who walk past me almost step on my legs without reacting. Anyway, I sit for a few minutes and try to work out what might have happened. But I come to no other conclusion than that it must be Jenny who is in some way involved.

Finally I get up to go. Without seeing me, a woman approaches who has a suitcase in one hand and a poodle on a long leash in the other. In order not to collide with the lady in question I take a step aside so that I get between the lady and the dog. Now I notice something so strange that I'm shocked. Instead of stumbling over the dog leash, it is just like the strap goes straight through my legs! I turn around to see if the lady reacted -as she should have done - But no, she continues on as if nothing had happened!

This was something new for me, which as far as I know has not happened before, so I turn around and follow her. Could I have imagined this, or what happened? Before I had time to catch up with her, I meet two young people, each with a bag in their hand. They swing with their bags so that they could mow down everyone they meet, and I get one bag in my chest. But the same thing happens again, it goes straight through me without me feeling anything! I have now caught up with the lady with the dog and go through the leash for the second time! I can't help but laugh at myself, because it's actually quite fun. I do it again and it works! I see a bench across the street and sit there to think about a bit. Am I here all by myself and if so why? How do I get home again? While I'm sitting on the bench, I think about why I do not fall down to the ground, or even straight through the ground. But I do not have long to think, because suddenly Jenny is sitting next to me!" I guessed that you'd be nearby! Now you have to explain everything that is happening, I understand nothing!"

"You're really both here and at home at the same time, but for now you're just here. There are means of travelling that you can avail yourself of almost anytime, and when the time comes, you know what to do"

- "I don't know what you're talking about!"

- "Ante, you get education at home when you sleep, you do not consciously notice any of it, but you get it anyway. You could not have made this trip here otherwise."

- "But I have not asked to come here."

- "Yes, you have, but not in a conscious state. You have to keep in mind that you are not the same old Ante any longer, you have a new view of things! You see everything from a different perspective than you did before. You know a lot that you had no idea about before, and you'll know how to take advantage of your knowledge when the time comes!"

"When it's time, you say. What do you mean by that? By the way, I don't want to be here any longer."

- "With the education and information you have received from me, you know when it's time for both one and the other. You think differently now than you do in a normally conscious state."

- "Do you mean that I'm not conscious now?"

- "Yes, you are fully aware of what's going on, but it's your other self that has not learned to keep up yet."

- "You're not saying that I'm two people at the same time, do you?"

- "No, not directly, but you have more than one consciousness. Don't worry, there's no detrimental effect and honestly, it's very positive."

- "But if I am now two, how can it be that the less knowledgeable part of me knows so much about the higher part?"

"Ante, you will notice that your ordinary self does not know as much about your other self as it thinks, but you learn from time to time I have noticed. The day you know what it is all really about you could write thousands of pages about your higher self. What you are now experiencing is just a drop in the ocean compared to what you've been through so far."

"Now take care and look around while you're here, but do not reveal yourself! I'll come back when it's nearly time for the journey home - take advantage and have fun too!"

- "Have fun, how and with what? I have no money for a start, and I'm hungry too."

- "You have, so you can manage. Good luck!" If someone had been watching us where we sat on the bench, the person in question must also have seen that she just disappeared into empty nothingness. I feel in my inside pocket if I have my wallet. I find one, and when I open it, I find exactly \$200 in different denominations! I'm hungry, so I go to look for a place where I can get some food. Busy with my thoughts I do not notice a group of punks or the like about taking up the entire sidewalk, but I collide with one of them. He swears after me, but now I discover that this time I felt like I bumped against something! This needs to be investigated!

A short way in front of me stands a cardboard box next to a house wall. I aim a kick against the box, and what a hit it was! It goes away in an arc, but only to stop up against the stomach of an elderly gentleman. He mumbles something, and I make an apology in poor English. At the same time, I ask him if he can show me a place where you can get some food. He shows me to a coffee shop where you can also order food to eat in. Behind a long counter are two older ladies, one on a high upholstered bar stool, a solid rotund lady, fat and fluffy, with a cigarette butt drooping from the corner of her mouth which probably remained there even when she slept. The other skinny and agile, with a cloth on her head, a dirty apron around her waist and a grubby towel draped over a shoulder.

Anyway, I sit down on a chair by the counter, because I was hungry. The fluffy one shouts into a room behind her, and out comes a younger dark-skinned girl in between fifteen and twenty years. I order a hamburger with cheese and bread and a bottle of chocolate milk. I do not want to sit in front of this smelly lady with the dirty towel, so I go and sit at a window table, so I can have a little nicer view. I do not sit for many minutes before the dark-skinned girl brings what I have ordered. In a slightly broken English, I wonder if I can have a cup of tea after the meal. She apparently understood what I wanted, because when she comes with the teacup

she asks if I want milk and sugar or a slice of lemon. Milk and sugar, I say, and she picks it up. Before she goes back, she asks if I'm here as a tourist, because she hears that I'm not from here. I tell her where I'm from and that I'm not going to stay longer than one night. I tell her also that I'd like to go out on the town and look around before I go home. When she takes the tray and go, I think about why I said I'll go home tonight. I don't really know when I'm going to leave. I light a cigarette and drink my tea. After a while she comes back and wonders I want another cup. I say yes. She asks if she can sit down for a while. You are welcome! I say. She talks about her name being Petra and that she goes to school but works here in her own free time. She wonders what my name is and what I do here in town. I say my name and that I'm here to have a look 'round for a bit. She thinks it's weird, but says nothing. I'm finding out that she is soon free. I don't know why, but I ask her if she would like to keep me company for a while after she is free.

Apparently she was happy that I asked her, for her whole face lights up. We leave together from the coffee-bar. She wants to buy some things, so we went into a big Department store. We went in and chat about Sweden and about my family. She knew some Swedish, about as much as I did English, but we understand each other pretty well anyway. Her neighbour had had a Swedish exchange student two years ago, and she had been together with her a lot, hence the Swedish. We went to a nearby park with coffee service where we sat and talked and told about ourselves. I never meant to ask her what her views were on UFOs, but on somehow we got into that topic.

Time went pretty fast, but we got a lot said anyway on the subject. She told me we had to meet again. I replied that it would be nice, but difficult due to the long distance." It's going well", I got the answer. Just after we parted, but I got a smile and a kiss on the cheek before she left. I sat there thinking about what had happened, when I suddenly saw Jenny outside the window! I pay the bill and go out. It has already begun to get dark. Jenny wonders if we should go and get us some food before we go home again. We find a small cosy place where we can bring something good to life. We get a steak with potatoes and various vegetables and a bottle of wine. Afterwards we drink coffee and tea. There are two lit candles on the table, and Jenny wants me to extinguish one.

"Why?" I say, "I guess it's just nice with candles".

But she stubborn, so I wet my thumb and forefinger to put it out, but she stops me. "You shall extinguish it without any mechanical movement nor blow it out. Try to imagine that it will go out!"

"Oh, come on now!" I say. "Admittedly, I've heard that it's possible to do certain things with only mind-power, but I can't do it."

"Try!" she says again. How it worked, I don't know, but when I looked at the light for a few seconds the flame starts to decrease to finally go out completely!

"It went well!" says she, "but now you can turn it on again!"

- "Own up, it was you who did it", I say so loudly that other guests react.

"No, Ante, anyone can do it, but it's important to know how to proceed. Your second consciousness I can handle such things but not your first, but you'll learn over time. Just remember that you must never use your hidden powers for commercial purposes and not to harm anyone or anything!"

"On the other hand, you can use it when an emergency arises, but in those situations your other self comes to the fore and helps you. And you should know that when you are asleep and dreaming - as you like you call them, it's your other self that exists. But your ordinary self is always there, that is how sometimes you can remember some of what is happening to you. Admittedly, there are things which you may not write down or tell anyone yet, but do not worry! When we see that you can handle your task in full, you remember everything that happens." We have now finished our meal and received coffee and tea. There are a couple

sitting across from us who also have candles on the table. I get the idea that I should joke a little with them and turn one off one of the candles with thought power! The man reacts quickly. He takes a match lying on the table to light it, but before he has time to light it - I have already lit it! I turn off the other, and the same thing happens. They start to worry about it, while both Jenny and I can't keep ourselves from laughing. But for some reason I do not continue, although I would like to. It's actually quite comical to see their reactions.

"You learn," says Jenny, "and it's good. Sure you can have some harmless fun, but it is nice that you can master yourself. And do not forget what I said that you can use it now and then, but not to harm anyone. "

She gets up from the table and says goodbye this time.

" But we'll meet again!" She says before leaving. I pay the bill and get two dollars change that I leave on the table before going to the toilet. I'm thinking I have to go home before someone wakes up at home! I get the feeling that I am starting to freeze, and I perceive a picture emerging from nothingness again, it is a picture of our house and our garden. I kind of merge with the picture, and shortly thereafter I am on the lawn behind the house! After a while I go in, the clock shows 4.16am, my wife is asleep. I put on some tea and light a cigarette. While I sit and think, I try to light one of the candles that stands on the table to repeat what I did before. But my disappointment is great when it does not work. Either everything is a dream, or I am my old ordinary self again, I don't know what to believe. I go to bed to get at least a moment of sleep before I go to work. But for some reason I was not the least bit tired. Now I just need to wait for the next experience and see what happens. I still do not know what to do think about what is happening to me!

### **Contact meeting in space (December 1986)**

Then it's winter again. One December evening, I decide to take a turn outside before I'm indoors for the night. Inside the neighbour's houses I can see there are still lights shining in a few places, they are preparing for the imminent Christmas celebration no doubt. When I get to the new school and have to turn right, I can see a bluish glow off towards the forest. It is slowly approaching the place where I am. After a few seconds it stops, and I stand still to see what's going to happens. The light becomes stronger and it is possible to distinguish the contours of a sphere, a few meters in diameter! It stays completely still for a while and then slides away behind a grove of trees. I don't have time to go more than a dozen metres, before it shows up again, and then disappears away towards the trees again. Apparently it wants me to follow, and I do.

It leads me away from the road towards the meadow and what do I see there, if not the egg-shaped craft I have met on several occasions before! Shortly afterwards a door opens on the underside and a staircase comes down. I wait a bit but then get up on-board. I see no one, but I am asked to sit down. Then it becomes quiet apart from some faint hissing. A voice tells me not to be afraid of what I'm about to see. I hear that he's someone I have not met before, but he means no harm, he's just going to take me to our meeting place. I hear someone coming up the stairs and towards the room where I'm sitting. I'm not scared, but the creature that now appears before me does not look exactly human.

He is 170-180 cm tall and is quite thin, has long, slim legs, a small narrow mouth and eyes with quite a narrow gap between them, a hint of nose, but rather large ears, slightly more pointed than ours, he is clothed in a set of tight-fitting overalls or jump-suit. He has a spruce twig in hand, I'll see why soon. He sits down in a chair in front of me, lays the twig on a table and presses some buttons. Suddenly the twig is bathed in an intense yellowish glow. After a while he takes the twig from the table and gets up. He comes up to me and takes me by the shoulder and says something but I do not understand. Then he goes to the pilot's seat and alters some controls. The craft begins to vibrate, and out the window - not perceptible externally - I see that we have lifted quite high above the ground. I can see where we are



going, apparently there is no hurry, because it does not go faster than 50-60 km per hour. It's now I get to see what he wants the twig for, he sits and breaks it into small pieces and puts them in his mouth. I wonder if it tastes good, so I ask him, but I get no answer. Instead, he hands me a piece, it's like getting an ice cube in his hand. I put it in mouth, it was really cold and hard, but after a while it melts like butter in the sunshine. I have tasted it before but can't remember what it was that tasted the same. It was pretty good, though he will probably keep the rest himself, which he does. We're getting closer to the meeting place, and I'm thinking about what's going to happen and why Jenny is not with us.

When we arrive, I can see another craft, but we don't land but instead go straight up, in tandem with the other craft. We have to be pretty high up, because I can see several collections of light below us, they must be cities. I feel that we are slowing down, and soon we are inside a large hangar, probably in one of the large vessels I visited earlier. When we have stopped and exit out of the smaller craft, I see Jenny and two others - both of them the weird the spruce-eating creatures. I hail them in greeting, Jenny answers, but the other two come forward and takes me by the shoulder like he did before. I ask Jenny what's happening now?

"You'll find out soon!" She asks me to come along, we go along a long corridor and into a large hall where there are some people that I recognize from before. We sit down. "Unfortunately," she says, "not everyone who should be here attended. Some have pulled out, some have not been able or willing to continue our contact, but it's not going too bad anyway". I ask her what it's all about and who picked me up.

"As I told you in the past, there are other civilizations, but some have annihilated themselves. Even with you it will be a mixture of biologically diverse individuals since you have annihilated yourself in the distant past, and you know about it. But that was not why you were brought here. Earlier I've talked to you about how we should show ourselves to you, and it is determined that we should do so. Our intention at the moment is not to get in touch with Earth humans just yet, but just to show that we exist. You will soon see a map which depicts where we should show ourselves. There will not be many places the first time, but there will be a few at a time in different 'appearance cycles'. We do not want to create any panic, but it should be calm and dignified so that no one is frightened, and at the same time I hope that we might receive some assistance from yourself?

- "As you know, we are not 'bad people', but rather the opposite. We must first hand prove that we exist, and only when we are accepted as good neighbours and brothers, then can we initially descend to ground level to take the next step. I don't have to go into that now, you know what it's about. And should it turn out that we are attacked, they can't hurt us with their usual weapons, and I don't think they would use nuclear weapons against us either, as it would only affect them more than us. So you do not have to worry about that. The biggest problem will probably be whether we are accepted or not."

"There are a couple of other things I would ask you," I say. "Are there any of you who is here permanently, or are you only here every now and then? And how often does someone from the Earth choose to accompany you? And is it true - as has been mentioned in some newspapers - that you have taken on board both humans and animals and done some research against their will?"

"To your first question, I can answer that there are always some of us with you, but it is not the same people all the time, they get exchanged after a while. We have not been with you that long yet, but you will notice that there will be more of us the closer we get to the time set for our visit. He who usually contacts you does not have that long left, he will be replaced in 6 - 7 months."

- "Who contacts me, you say? No one contacts me. Admittedly, I do meet someone who occasionally says that he comes from a place not so far from here, and who speaks with a slightly different accent and also looks a bit different in some respects, and that in addition, he has a certain ability to appear and disappear when you least expect it. But still, can you answer my second question about how many times someone goes over to you?"

"We've talked about that before, but I can say that it's probably about a few hundred per year. And on your third question, I can only say that no-one has come on board and been subjected to some form of examination against their will. Anyone saying otherwise is wrong. The few who have come on board have been asked if we can take some minor physical samples, and we have accepted if they have not wanted to allow that. And no one has been forced on board nor, on the other hand, are many who have a feeling of having been more or less dragged on board, and that includes yourself."

"And as for the animals, the only living animal that has been on board is a bird that had injured a wing. We helped it until it could fly again, then it was released. You can by the way, be proud of your fellow human beings who work against animal testing. We think it's cowardly to engage in harmful and painful experimentation on defenceless animals - without them being able to give their consent. Let your last animals live a free life! Why should the animals pay in pain, suffering and death? - and who has given you the right to do so by the way?"

I can do nothing but agree with her, because I have exactly the same opinion myself. Finally, I ask her if I could not get any concrete proof from her that they really do exist and everything is not just my imagination.

"Is it for yourself or for others that you want proof for your experiences?" she says. "You have the best proof within yourself, you have to believe in yourself and don't care so much about what others believe and think. Time enough for them to see that you're right! "

We say goodbye to the big vessel and head home.

## **Second visit to the seabed (02-Sept-1988)**

After a long pause, I finally hear from my space woman Jenny again, this time we meet at ten in the morning. I go out to the arranged meeting place at half past nine and sit down and wait for her to show up, but she does not come. Instead, I notice a craft a short way towards a headland, so I get up and go there. When I arrive, a piece of the wall appears to slip off to the side and an opening becomes visible. When I get into the craft, the wall closes, and I can feel the usual vibrations. We go straight up, incredibly high, because I can see both the west and east coasts. Then we change course and go south, over Holland, Belgium, France and further over Spain, where we turn slightly west towards the Atlantic. After a little while we go down to such a low altitude that I can't discern which country we are above. After at most an hour's flying, we suddenly stop and go down into the water, to stop just above the water surface. I see that my pilot is tinkering with a few buttons and a steering wheel. The pilot, that is my barefooted friend from a previous meeting. Then we start moving again, but not upwards but downwards into the water! Through the wall I do not see much other than foam and bubbles, and it's pretty dark. But then it gets brighter again, and we are in a (bottom-lit?) valley, consisting of both rolling and undulating slopes and high, pointed cliffs (or maybe I would say mountain ranges). So we stop right in front of a rock wall, and in the wall there is a huge thick and heavy gate that opens by sliding to the side! From what I can see, it's of metal, about 25 x 25 meters square and maybe 5-6 meters thick.

When fully open, we slide into a huge cave - maybe a couple of square kilometres - with a very smooth walls along the sides to a height of 50-100 meters. Above the smooth lower wall are higher rough surfaces. We have kept to a ledge that seems to extend around the entire cave, and in the cave other egg-shaped craft are parked adjacent to additional gates and doors with stairs leading up to other ledges. My pilot has left 'my' craft, swimming over to a door set into the rock. It opens, and a room can be seen inside. This must be some type of lock, and even the large cave must be built so that it can be drain water. Why else would there be a need for stairs and railings on to and off of the ledges? (Which are at the moment

submerged) Another thing that strikes me is that the large gates are numbered with ordinary numbers (Arabic numerals). At some other places I have seen only a few geometric signs, squares, triangles, circles and points. Between some of the gates there are some kind of graphic, and on these are maps drawn. Obliquely behind me is an entrance labelled with the number four, I can even see a six, a seven, a one and a bit above the seventh is a five. Between the sixth and fourth gate hangs a picture with a map of Europe, Africa, North and South America, Greenland and Antarctica. In the Atlantic between North Africa and Florida on the map there is one large marking with a red circle, and from this circle, several red lines go out to different places on the map, including to the North Sea and the Arctic Ocean. The lines leading to the North Sea are numbered fourteen, the same as on one of the gates in the cave. Line number four ends slightly outside the Dutch or German coast, to branch out there in four more lines. If I remember correctly so one went to Austria, one to Norway and



Sweden, one over to England and one to the Soviet Union. For each line on the map, there seems to be a matching number on one of the smaller gates in the cave walls. It seems these gates lead to some kind of passage or tunnel underground or out into the water, but I can't be sure. It must have been about half an hour since my pilot left, but now I can see him again coming through a door in the wall.

Next to the door beams a blue light, and shortly after he passed it glows red or yellow-red. I hear a sound, and shortly afterwards he is inside the craft again. The large gate opens, but we do not go directly out of the cave but follow the wall inwards. When we have reached the far end of the cave so I can see something incredible, in the rock

wall there are large windows, 10- 12 meters wide and 5-6 meters high, and inside these windows there is life and movement! It looks like a workshop of some kind, there are craft, both like the ones I have seen before and others new to me, and there are human beings working on something! When we pass the last the window I also get to see something at least as strange, namely rockets or the like! On one of them it says 'United States' in large white letters and something more that I don't understand before the room behind the window gets dark. I immediately start thinking about what I have seen and I try to get answers by my pilot, but he is very quiet. Shortly thereafter, we exit the cavern complex, on our way through the valley and so up to the surface. After about an hour we are back at the starting point at home in Småland (a province in southern Sweden).

The whole trip took no more than a maximum of three hours, including the cavern visit. Once at the beach, I'm just getting back to my car, when I discover Jenny, my space woman! No one can be happier than me when I see who it is. We're talking about what happened when I got a wild idea in my head. Can't we go home to my house and drink a cup of tea? She laughs and asks if I dare. "It's clear that your clothes might attract attention Jenny", I say, but she calms me down and after a while we end up sitting at my home, in the living room with a cup of tea. During the conversation about the events in the sea cave, I get to the rockets I saw, and then she becomes just a little more serious. "They have been found in different places," she says, "and they came not only from the United States but from many nations."

She says, that authorities in different countries lack nuclear weapons but keep that a secret. "Several of these rockets could have started a nuclear war if we had not taken care of them, unfortunately I can't say more this." After the conversation about the rockets, she was not really the same anymore, she was not the happy and alert one Jenny that I was used to. I've never seen her so serious and sad as she was now. "Don't trust too much in the promises and great talk of certain nations re disarmament, I can tell you that there has never been so much armour on your land as now". she says. "What they are doing now is preparing for a war that

could well wipe humanity off of the face of the Earth. You have to believe me Ante, at the moment there is a sixty percent likelihood of a nuclear holocaust predicted, and it's increasing a few percent every year that nothing radical is done." We carry on talking about other things, and we end up going to the beach. After we have talked for a long time, she is picked up in the same way as before and I return Home. But so much is certain that I will never be able to stop thinking about Jenny, my amazing space woman and her friends from out there somewhere!

### **Renewed contact (30-Mar-1989)**

It has now been several months since my last meeting with these people, I had almost gave up hope of meeting them again. But in the afternoon of March 29 the phone rings and I pick it up. A voice that seems to be inside my head rather than inside the phone says we'll meet at 9pm the following evening! I hang up and tells my other family that it was apparently a mistake. The next day at 8:45pm I leave for what I believe to be the meeting place. This time I have with me a mini camera and I've prepared a few questions that I hope to get answers for. I arrive, park the car and go down to the lake. I see that there is someone on the headland to the left, about 50 meters away. I stand and look at the person. He's already started coming towards me when I heard a sound behind me. There's a "spruce rice eater" that I usually call them, and when the person from the headland comes closer I see that he is of the same kind.

No vessel is visible. We go and sit on a raised wooden bridge. It is overcast and quite cold and they probably perceive that, because one of them brings out a square device from a container he has with him, a device turns out to be some combination of heat source and lamp. It warms up nicely and shines with a pleasant glow. I says that it must be visible to the road and the houses, but he explains that it is not visible. To convince me, we go a short distance from the place, and the light becomes dimmer the further we goes to disappear completely after 40-50 meters. It is one very peculiar light, duller than the glow of an ordinary lamp. He says it's a light bulb, powered by shale carbon and magnesium and ignited by a magnet. As we sit around the lamp, I see what they really look like.

They are about 150-160 cm tall, rather sparsely built, with a pear-shaped head, half the size of ours. They are lighter in complexion, have no hair on top the skull, on the other hand, somewhat thin, dark blonde, whisker-like hair from the small and flat ears down to the chin. They have narrow lips, a slight hint of nose and rather large eyes. On the scalp are four narrow metal rails, attached to a ring at the neck between the ears. Two of the metal rails go down towards the forehead above the eyes and two at the side of the eyes. He is wearing a tight-fitting overall which appears to consist of about 2 cm large metal plates.

The overall is comprehensive, it goes all the way down under the soles of the feet but ends at the wrist, where some kind of gloves take over. He also has one black belt - probably of metal - with some symbolic signs. There are two white triangles that shines dimly, two standing rectangles with a pink glow varying in strength, and a symbol consisting of two intersecting circular segments between two vertical lines. One vertical line on the rectangle reacts when I talk to him and sort of follows my voice. From the belt go two rails over his chest up to a metal ring that he has around his neck, and on the rails are three white rounded plates, two on his right side and one on his left. On his left shoulder sits one small box with two buttons and something that looks like a socket.

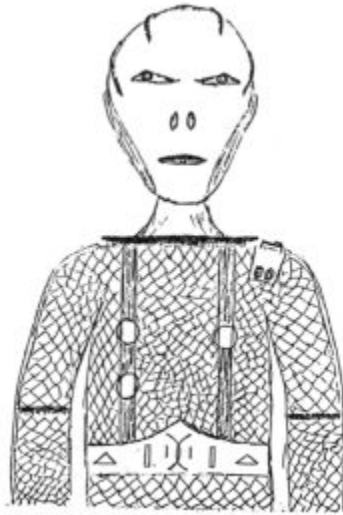

Both persons are alike, except that the other one has a bag hanging to the side and something resembling a tuning fork. I ask what is going to happen now and why they contacted me. "We want to know if you're still interested in keeping your promise to us as a contact person. If so, you should all get the information required to be able to maintain contact with us and the others. "I answer yes to their question and wonder in turn if they can tell where they come from. "We come from a long way from here, but still from a place in the same system that the earth is part of. We have stations close by, including on the earth in three different places. You've been to two of them, down in the oceans, the third place is on the surface of the earth, but hidden so as not to be discovered by you. The one on the earth's surface is the oldest. Then we have six more stations on different planets, but I can't say which ones."

- "Are these planets far away from Earth?"

- "About two days' journey."

- "I have been on your home planet, it does not seem to be that far away."

- "You've never been to our actual home planet, but only to a couple of our stations. But we have been there for many years at a time, so in a way you have still been at home with us."

I further ask how they can move their craft so quietly and quickly and sometimes more or less invisible, and if their craft is also powered by coal and metal like this strange lamp/heater. They answer that slate carbon and magnesium are included, although it is a long and expensive procedure to convert it to fuel. But once it's done, it's enough to run for three years. To charge these batteries consumes huge amounts of electricity. When I asks how big the batteries are, he takes out of his box a smaller box, a couple of square centimetres large. He says that with it I could drive a car for so long, that the car would have been worn out several times before the battery is half discharged.

He can also regulate the strength of the light from the lamp in front of us. I ask if there will be any waste products during manufacture or use. "One gas is formed which for us is harmless, but unfortunately it has happened that some of you who have been in contact with us have become ill and in some cases died. We are working to make it safe but before it is clear, we can't share that knowledge. I asked why I didn't become ill, when I have apparently been exposed to it on several occasions. "You've been given an antidote, which is also costly and time consuming to produce. That grey liquid that you drank - that's the antidote." To my question asking to take a photograph of them before we part, he answers that we are not really mature enough for it yet, and that I'll have to take it in the future. I wonder if I can feel the suit he is wearing?

"You are welcome!" he says, looking at his friend and smiling a little tricky. Before I put my index finger on his suit, I see that one of the triangles in the belt begins blink, the closer my finger gets, the more intense it blinks. When touched it burns so that the burning makes me

yell and pull my finger back. I'm offered another chance to feel the suit again, and it feels normal, so they can apparently quickly regulate the temperature of the suit. I'm told it's made of a kind of metal fibres. I say I thought about how they can be underwater without any special diving suit. "Our suit is very special," he says, "with the help of the suit we can create an invisible energy fields around us that repel the water for a short while." He shrugs where the little box sits, then he walks towards me. When he is half a meter away, it feels as if an invisible wall is pushing me aside! When it's time for us to part, he makes a movement over his belt, and after a while he lifts from the ground (!), one followed by the other. I see them 15-20 meters up, then they are gone! Halfway home in the car I see a light across the road, it flashes a couple of times and so on is it gone. It must have been them.

### **The last meeting (29-Jul-1989)**

It's been a while since we met, but now it's happened again. I was contacted, but not in the usual way. I was on my way to the village by bike, when I was in front of the police and the fire station I meet a man unknown to me, walking towards me who beckons me to stop. I wonder what he wants, he says only four words: "The meeting place tonight!" He crosses the street and disappears between the houses. When I look for where he went, there's no trace, he's already gone. The day goes by, I go to the meeting place and sit down and wait. After 10-15 minutes two people come up to me, the one I saw before and Jenny! They settle down on the pier opposite me, and I find out that it will not be that long. I also get to know, that the man is an observer deployed by them, and that there are thousands of others deployed in same purpose. We talk a bit about me personally, about my future book and about any reactions from my family and my friends. After the conversation about me, the man gets up and walks a little away and sits down again. When I look in his direction, another person has appeared. They leave, walking along the shore, then they disappear behind some bushes and trees. Who the other person is I don't find out. When I ask Jenny about the reason for this meeting, she says she first has to talk about some boring and negative things, but also some positive ones. She says I should be on my guard, because now things have started to happen in different parts of the world, and everything is pointing to the same thing. It will probably be a war, which will affect large parts of the world's population! "It's going to be so devastating that you'll probably be hit by a wave of diseases that you can't cure. These are not ordinary radiation injuries but something completely Other."

She is not initially willing to provide further details, but does in the end. She's talking about the destruction of the delems by their own hand, with us it will be the same.

"The damage that comes from this radiation which we call return radiation is the worst and for you a completely unknown effect. It is common for bone structure, teeth and nails to more or less turn into a fine powder. It can take several years after someone has received the radiation, but it can also only take a few seconds. The body otherwise it remains intact." I ask her how to detect and cure such an injury. "You will not discover it until it is too late. Once you've got it, there's no going back. "She asks me if I have ever had a toothache, real pain? Imagine such a pain in all teeth and in fingers and toenails! Then add pain to all the bones in your body and think that this can continue for several years. If you are lucky, it can all be over in a day or second. You can sit on a chair or be out for a walk, when completely without warning the bones in your body go up in smoke. You just fall together like a shapeless mass, and soon after you are dead! Imagine that you yourself walk down the street and meet someone who just becomes a pile of meat in front of your eyes,, or that your family come home and they find you like shapeless piles on the floor!"

"I can tell you, it really will be that way if the war breaks out, even if your doctors and scientists do not believe it. But greet them from me, that they will discover both this and much more in the event of a war!"

"As I said, there is no cure once you are affected, but it can be prevented in one very simple way. I'll give you a recipe for a very good and unusual drink, that's it. It is the only cure we

know of. I really do not need to tell you this, because you know your place in the context." I do not really understand what she means by the latter, even though I have heard it several times before, nor do I dare to ask. Both that and much else that I had planned to ask questions about is just blown away. This was apparently the negative thing she had to say. Later, the conversation concerns me as a private person, but I find out that they think within a three-year period to contact a further number of people of both sexes. I wonder if they should get it too visit their home planet, but get the answer that none of us have really been there. We have only seen some bases that they use. Their real home is so far out that it takes several years to get there. As usual, I forget to ask where their homes and bases are located, and the conversation slips over to small talk, including about this book that we will publish. Then it's time to part again.

The last thing she says is, "Say hello to Sune, he's not that stupid!"

We say goodbye this time, but I'm already waiting for the next one!

---

Thanks to David Walsh in England for proofreading the language

link til den svenske <http://rune.galactic.to/ante-ufo.html>

**[New: interview with Ante](#)**

